

drumlogue

HYBRID DRUM MACHINE

Owner's Manual

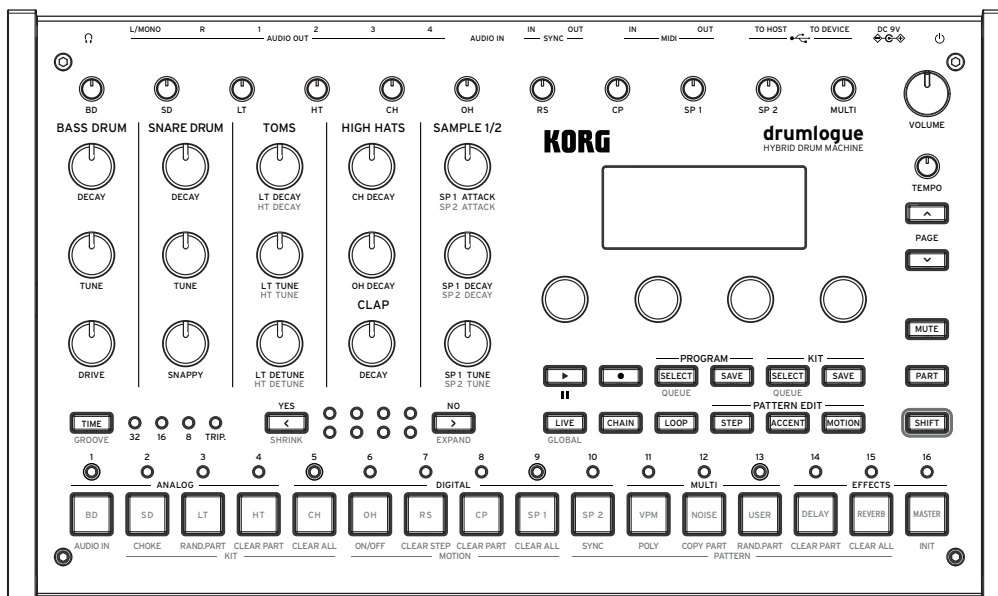

KORG

Table of contents

Introduction	3	Miscellaneous	53
Main Features.....	3	Restoring the Factory settings	53
Block Diagram	4	Preset programs/Drum kits	54
Panel description and functions	5	Specifications.....	56
Front panel.....	5	MIDI Implementation Chart	57
Rear Panel	8		
Making Connections.....	9		
Operation Guide	11		
Turning the power On/Off.....	11		
Quick Start	12		
Programs and Drum Kits.....	14		
Sound source configuration of this unit ...	14		
What is the drum kit?.....	14		
How to make a sound	15		
Using the Sequencer	16		
Transport.....	16		
Editing a Pattern.....	19		
Chain mode.....	20		
Loop mode	21		
Using the SHIFT function	23		
Sound Source Parameters	26		
Analog sound source parts (BD, SD, LT, HT).....	26		
Digital sound source parts (CH, OH, RS, CP, SP1, SP2).....	30		
Multi-sound source parts (VPM, NOISE, USER)	33		
Effects (DELAY, REVERB, MASTER).....	38		
Global Parameters	44		
Understanding MIDI and Computers ...	49		
Connecting Devices via MIDI.....	49		
MIDI-Related Settings.....	50		
Connecting a computer	51		

Introduction

Thank you for purchasing the Korg drumlogue hybrid drum machine. To help you get the most out of your new instrument, please read this manual carefully.

Main Features

- In addition to analog and digital sound sources with basic drum tones, this product is equipped with a multi engine including Noise, VPM, and User Synth sources, enabling you to make a wide range of sounds.
- This product is equipped with dedicated knobs that allow you to instantly control the tuning and attenuation of commonly used bass drums, snares, toms, and other instruments.
- There are up to 128 (16 types x 8 banks) programs that are all rewritable.
- There are up to 128 (16 types x 8 banks) drum kits that are all rewritable.
- This product is equipped with a powerful sequencer of 11 parts and 64 steps. Various performances can be created in combination with the loop and chain functions ("Chain mode" p.20, "Loop mode" p.21).
- Master effects can be used simultaneously with reverb and delay.
- SYNC IN and SYNC OUT jacks allow you to expand your session setup.

Block Diagram

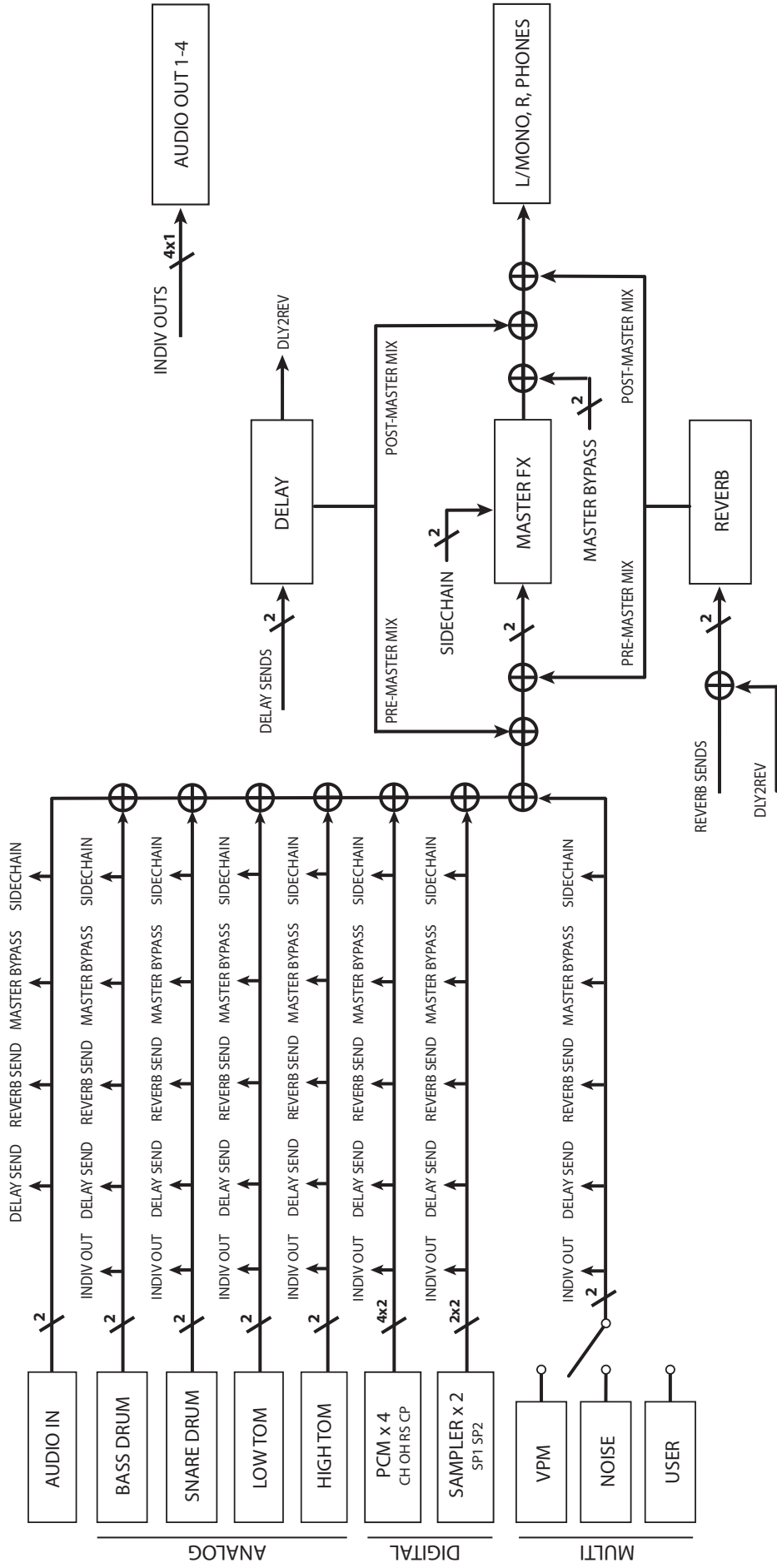

Panel description and functions

Front panel

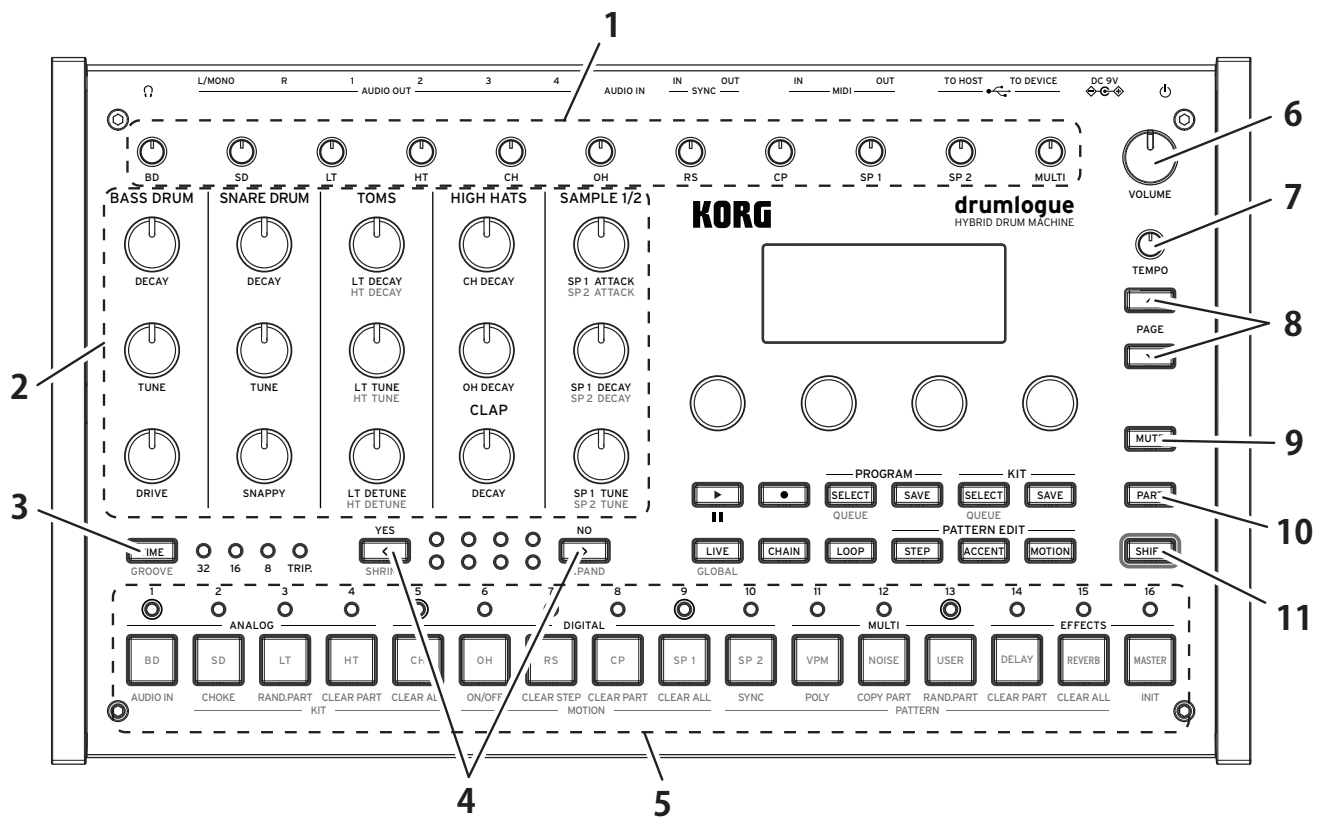

1. Mixer section

Adjust the volume for each drum part.
The adjusted volume can be saved/loaded for each drum kit.

2. Kit control

You can change the parameters of the most commonly used parts of the drum kit in real time.

3. TIME button

As long as you hold down this button, the time settings are shown in the display. You can change the setting using parameter knobs 1 to 4. In addition, if you press the TIME button while holding down the SHIFT button, you can access the GROOVE function ("Time and groove" p.16).

4. < (YES) button, > (NO) button

Moves the currently displayed bar forward or backward. In addition, use this button to execute (YES) or cancel (NO) when an operation prompting a confirmation such as Overwrite Save appears. If this button is activated with the SHIFT button, you can change the pattern length ("Changing the number of bars and steps (SHRINK button, EXPAND button)" p.17).

5. Buttons 1 to 16, LEDs

The 16 buttons are arranged from left to right as follows: analog sound sources

(BD, SD, LT, HT), digital sound sources (CH, OH, RS, CP, SP1, SP2), multi-sound sources (VPM, NOISE, USER), and three effect settings, which can be accessed. In addition, the LEDs above the 16 buttons show the pattern's step information.

6. VOLUME knob

Adjust the volume of the entire unit. This is useful for L/MONO, R, and headphone output.

▲ AUDIO OUT1 to 4 are not affected by activation of this knob.

7. TEMPO knob

Adjust the tempo of this unit to be between 56.0 and 240.0 BPM.

▲ Tempo information is provided for each program. You can set whether to use the value saved in the program when switching programs or to give priority to the value of the current TEMPO knob (→ p.44 "TEMPO").

8. PAGE UP/DOWN button

If items span over multiple pages when you are editing parameters, use this button to proceed to the next page or the previous page.

TIP The indicator such as "1/2" (first of two pages) appears in the upper right corner of the display.

9. MUTE button

If you press one of buttons 1 to 13 (BD~USER) while holding down this button, all steps of the part of the button you pressed are temporarily turned off and muted. To cancel Mute mode, press the button(s) assigned to mute from among buttons 1 to 13 while holding down the MUTE button.

10. PART button

While holding down this button, press one of buttons 1 to 16 to switch the drum part and the effect you want to edit. This is effective for pattern editing, etc. In addition, while holding down this button, press the VPM/NOISE/USER button to select which MULTI sound source to use.

11. SHIFT button

While holding down this button, operate the knob or button to which the shift function is assigned. For example, you can edit HT TUNE (high tom tuning) by turning the kit control LT TUNE (low tom tuning) knob while holding down the SHIFT button.

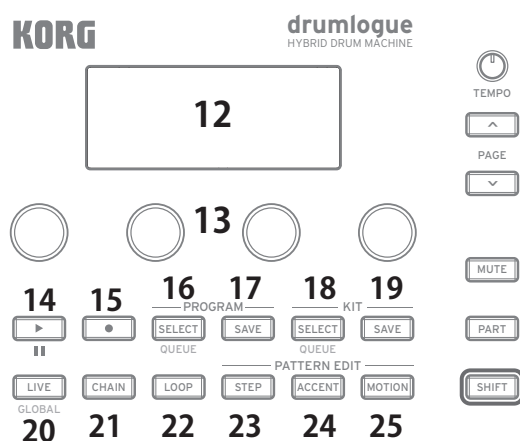

12. Display

This display shows information such as the current program, drum kit, and pattern step as well as various parameter setting values.

13. Parameter knobs 1 to 4

Select the item shown on the display or change the parameter value. If setting items span over multiple pages, the indicator such as "1/2" (the first page of the two pages) appears in the upper right corner of the display. Use these knobs in combination with the PAGE UP/DOWN button.

14. (PLAYBACK)/(STOP) button

Each time you press this button, this unit starts or stops playback. If you press the button again after stopping, playback starts from the beginning of the pattern. Each time you press this button while holding down the SHIFT button, playback starts from the pause or stop position.

15. (REC) button

Used for real-time recording. Each time you press this button, recording switches between start and stop. In addition to steps, you can record accent, knob, and parameter motions (MOTION).

TIP For step edit, press the STEP button.

16. PROGRAM SELECT button

Press this button to select a program for this unit. If you press this button while holding down the SHIFT button and select a program, you can switch to a new program at the end of a bar or pattern (→ p.44 "QUEUE (QUEUE MODE)").

17. PROGRAM SAVE button

Press this button when saving the changed program to this unit. You can save up to 128 programs in total; 16 programs each in eight banks, A to H.

18. KIT SELECT button

Press this button to select a drum kit of this unit. If you press this button while holding down the SHIFT button and select a drum kit, you can switch to a new drum kit at the end of a bar or pattern (→ p.44 "QUEUE (QUEUE MODE)").

19. Kit save button

Press this button when saving the changed drum kit to this unit. You can save up to 128 programs in total; 16 programs each in eight banks, A to H.

20. LIVE button

Press this button to shift to Live mode. In Live mode, you can press buttons 1 to 13 (BD to USER) to check the sound. You can also set global parameters by pressing this button while holding down the SHIFT button ("Global Parameters" p.44).

21. CHAIN button

Press this button when using Chain mode, which allows you to connect multiple rhythm patterns to enhance performance ("Chain mode" p.20).

22. LOOP button

Press this button when using Loop mode ("Loop mode" p.21).

23. STEP button

For each step of the pattern, press this button to set the step parameters such as the step on/off status and the probability at which a sound is produced when the step is on.

24. ACCENT button

Press this button to set the accent parameters for each step in the pattern.

25. MOTION button

Press this button to record various parameter values for each step of the pattern.

Rear Panel

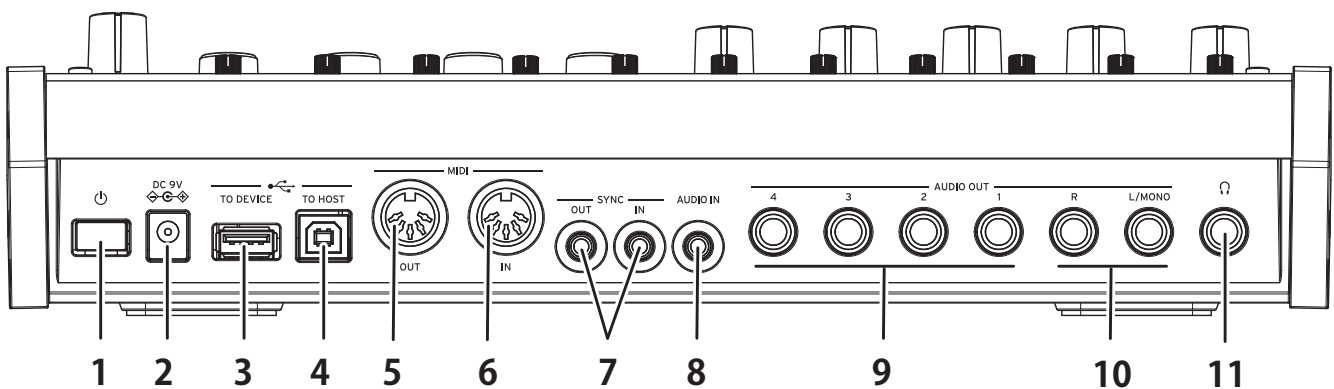

1. (POWER) button

This switch turns this unit on and off.

To turn off the power, hold down this button until the display disappears.

2. DC 9V jack

Connect this jack to the included AC adapter.

3. USB TO DEVICE jack

Directly connect to the MIDI controller using the USB cable to receive MIDI data.

- This jack is only used to receive USB MIDI messages. To connect to your computer, use the USB TO HOST jack.
- For a USB MIDI controller that consumes a large amount of power, use the power adapter that comes with the controller.
- This jack cannot be used for a USB MIDI controller that has a USB hub function.

4. USB TO HOST jack

Connect your computer to exchange MIDI data.

5. MIDI OUT connector

You can connect an external MIDI device to play while using the sequencer or drum pad of this unit.

6. MIDI IN connector

Connect an external MIDI device to this connector when using this unit to create sounds.

7. SYNC IN, SYNC OUT jacks

Connect to the SYNC IN and OUT jacks on the KORG Volca series, to synchronize with the output pulses and steps. The SYNC OUT jack outputs a 5V pulse, 15 ms long at the beginning of each step. Use a stereo mini-cable for this connection.

8. AUDIO IN jack

Connect an external sound source such as an audio player.

9. AUDIO OUT1 to 4 jacks

There are four independent output jacks that are separate from the main output of this unit. You can specify and output your favorite parts. Connect to mixers, audio interfaces, powered monitor speakers, and others.

10. AUDIO OUT L/MONO, R jacks

These are the main output jacks of this unit. Connect to mixers, audio interfaces, powered monitor speakers, and others.

11. (Headphones) output jack

This is a 6.3 mm stereo jack. Connect the headphones here. This jack outputs the same signal as that of the AUDIO OUT L/MONO or R jack.

Making Connections

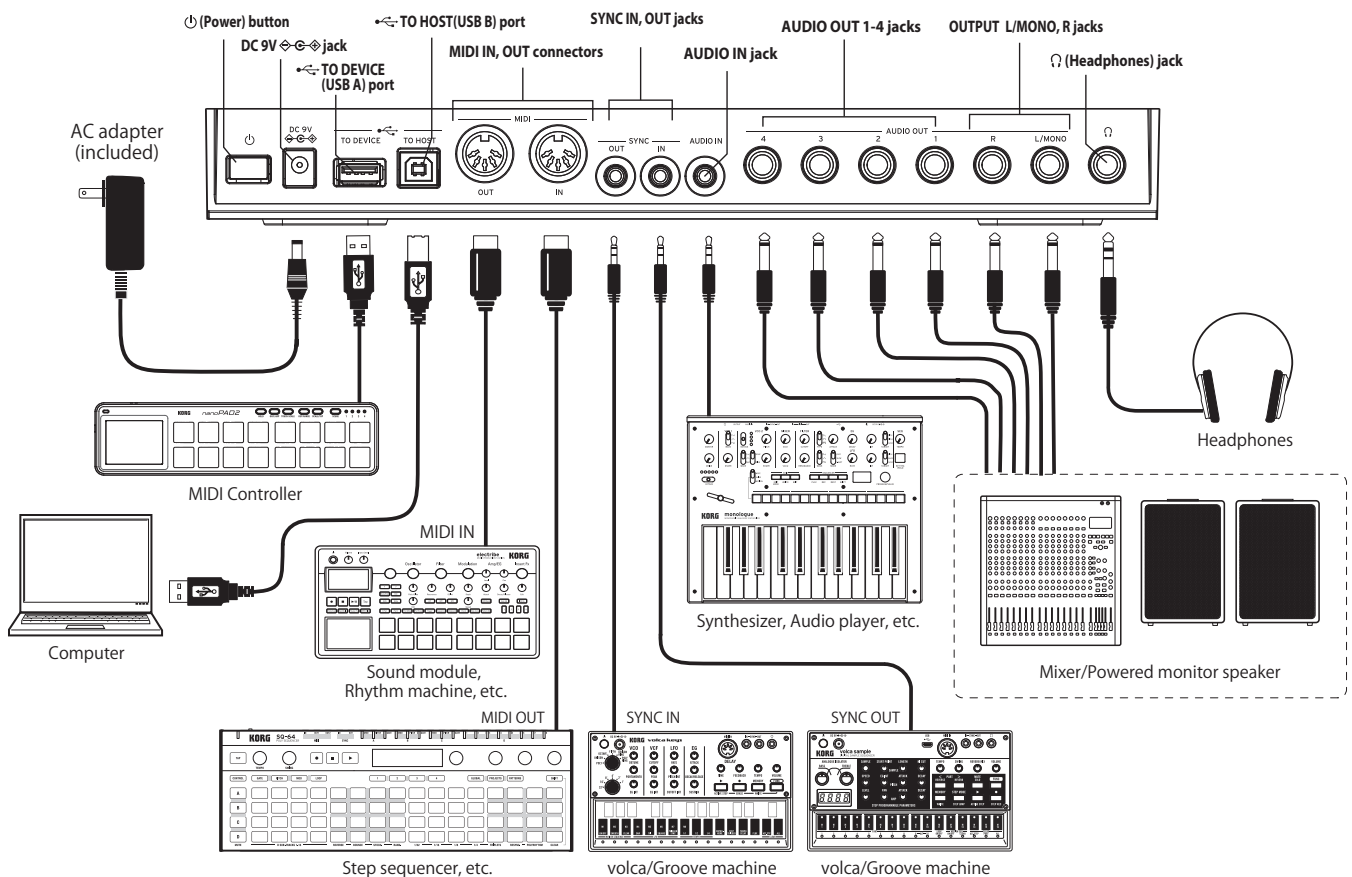

Connecting the AC adapter

1. **Connect the DC plug of the included AC adapter to the DC 9V jack on the rear panel of the drumlogue.**
 - ⚠ Be sure to use only the included AC adapter. Using any other AC adapter may cause malfunctions.
2. **Connect the plug of the AC adapter to an AC outlet.**
 - ⚠ Be sure to use an AC outlet of the correct voltage for your AC adapter.

Other connections

Connect the devices as appropriate that you will use.

- ⚠ Be sure that the power on all of your devices is turned off before you make connections. Leaving the power on when you make connections may cause malfunctions, or damage your speaker system and other components.

Audio equipment

AUDIO OUT L/MONO, R jacks (impedance-balanced 6.3 mm TRS phone jacks): Connect these TRS jacks to a mixer, audio interface, monitor system, etc. Adjust the volume level using the VOLUME knob.

🎧 **Headphone jack** (6.3 mm stereo phone jack): Connect the headphones here. This carries the same signal as that of AUDIO OUT L/MONO and R.

MIDI device

MIDI IN, OUT connectors: Use these connectors to connect the drumlogue to an external MIDI device for exchanging MIDI messages. Make sure that the MIDI channels are set appropriately ("Connecting Devices via MIDI" p.49).

Computer

USB B port: Connect this to a computer to exchange MIDI messages and data ("Connecting a computer" p.51).

TO DEVICE (USB A) jack:



You can directly connect a device such as a MIDI controller to this unit to play music ("Connecting a computer" p.51).

Operation Guide

Turning the power On/Off

Turning the drumlogue On

Make sure that both the drumlogue and any external output devices such as powered monitor speakers are turned off, and turn the volume of all devices all the way down.

1. Hold down the Power switch  on the rear panel of the drumlogue; once the “drumlogue” logo appears in the display, take your finger off the Power switch .



KORG drumlogue

2. Turn on any external output devices such as powered monitor speakers. Adjust the volume of your external output equipment, and adjust the drumlogue’s volume using the VOLUME knob.

Turning the drumlogue Off

1. Lower the volume of your powered monitors or external output system, and turn them off.
2. Hold down the Power switch  on the rear panel of the drumlogue; to turn off the power after the display goes blank, take your finger off the power switch.
 - ▲ Once you have turned the drumlogue off, wait about 10 seconds before turning the drumlogue on again.

Auto Power Off Feature

The drumlogue features an Auto Power Off feature that can automatically turn the drumlogue off after 4 hours have elapsed with no operation of the knobs, switches, or buttons of the drumlogue. By default, the factory setting for the Auto Power Off is enabled. The Auto Power Off can be disabled using the steps below.

To disable the Auto Power Off feature

1. While holding down the SHIFT button, press the LIVE button to enter GLOBAL mode.
2. Press the DELAY button to enter the “HW SETTINGS” page.



HW SETTINGS -GLOBAL-
BRIGHT AUTO PWR
5 ON

TIP You can also move pages by pressing the PAGE UP/DOWN button repeatedly.



3. Turn Parameter knob 2, and select "Off".
4. Press the LIVE button to exit GLOBAL mode.
TIP Settings in GLOBAL mode are saved automatically.



Quick Start

Playing/stopping a pattern (Live mode)

When this unit is turned on, it first enters this state (Live mode). Press the LIVE button to return to this state. If you are unsure about operations, try pressing this button.



1. Press the  (PLAY) button to play the pattern and the rhythm.
2. Use buttons 1 to 13 to play each part, or turn the TEMPO knob to change the tempo.
3. Press the  (PLAY) button again to stop the pattern.

TIP Press the  (PLAY) button while holding down the SHIFT button to pause. To resume from Pause mode, press the  (PLAY) button while holding down the SHIFT button again.

Selecting a program

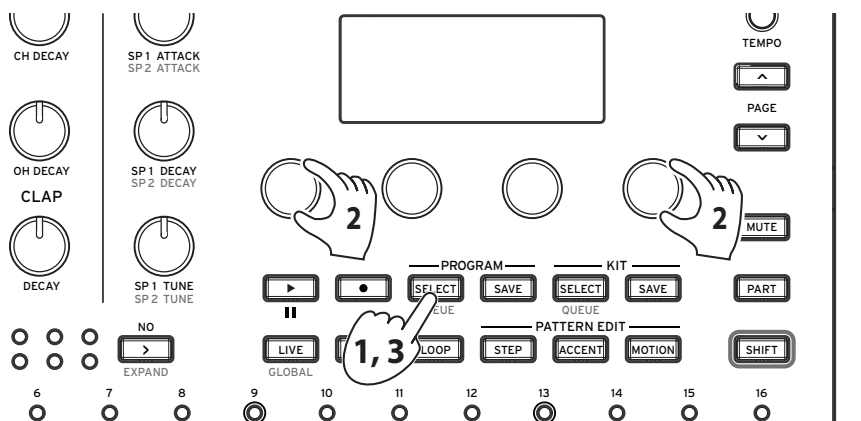

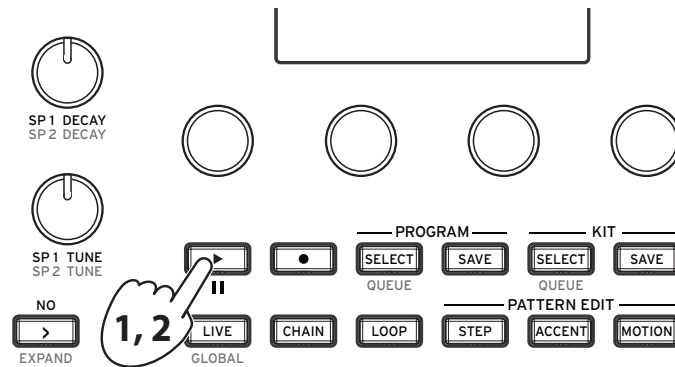

1. When you press the PROGRAM SELECT button, it enters the standby state to load a program, and the PROGRAM SELECT button blinks.
2. Turn Parameter knob 1 & 4, and select a program that you want to load.
TIP You can also select 16 programs in the same BANK by pressing the corresponding buttons 1 to 16.
3. When you press the PROGRAM SELECT button again, the program will be loaded.

Playing a rhythm pattern



1. Press the  (PLAY) button. The rhythm pattern of the currently selected program is played.

2. To stop playing, press the  (PLAY) button again.

TIP Press the  (PLAY) button while holding down the SHIFT button to pause. To resume from Pause mode, press the  (PLAY) button while holding down the SHIFT button again.

Using mixer knobs and kit controls

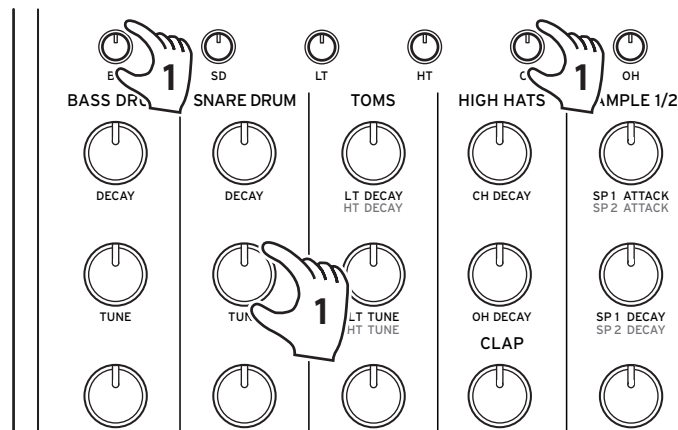

1. Use the knobs in the mixer section to adjust the volume of the bass drum and snare, and the control knobs to change the tuning.

TIP The balance of each part of the drum kit adjusted here can be saved for each drum kit.

Changing the tempo

Turn the TEMPO knob to set the tempo of the pattern. The tempo setting range is from 56.0 to 240.0 BPM. The tempo is saved for each program; however, use the global parameter ("OPERATIONS (Button 1)" p.44) to set whether to use the tempo for each program or to give priority to the tempo with the TEMPO knob turned.

Programs and Drum Kits

Sound source configuration of this unit

This unit provides 11 voices in total: Four analog sound sources (BD, SD, LT, HT) with the basic drum tones, six digital sound sources (CH, OH, RS, CP, SP1, SP2), and multi-sound sources (VPM, NOISE, USER). You can put your own sample in the digital sound source parts. You can select one of the three multi-sound sources.

What is the drum kit?

A "drum kit" is constituted of the parameter values of all 13 parts. The drumlogue can store up to 128 drum kits (16 kits for each BANK A to H).

The information about which drum kit you are using is stored in the program of this unit. Information about tuning, decay, and timbre of each part is stored on the drum kit side. At the time of shipment from the factory, each program uses the same bank and the same drum kit number, and the tone parameters are automatically saved in the drum kit when the program is saved.

You can switch the same sound with different patterns to play (as if assembling a song) by making a setting to use one drum kit with multiple programs. Conversely, you can play the same pattern with different sounds by changing the drum kit used by the program.

How to make a sound

There are two ways to make sounds.

- Select an existing drum kit that has a sound close to the one you want to create, and then partially edit using that drum kit as the base to achieve the desired sound.
- Create your own sound from a drum kit in its initial state.

Sound creation is performed by changing the basic parameters (kit controls) and detailed parameters (parameter knobs 1 to 4). Adjust the volume of each part using the corresponding knobs in the mixer section.

If you press the LIVE button to switch to Live mode, you can preview the tone of each part by pressing buttons 1 to 13. First, let's check what kind of sound is made in Live mode.

- ▲ We recommend that you save the edited drum kits and programs to this instrument as soon as possible. Any edits that you make will be lost if you turn off the power or recall a different program.

Saving a Program

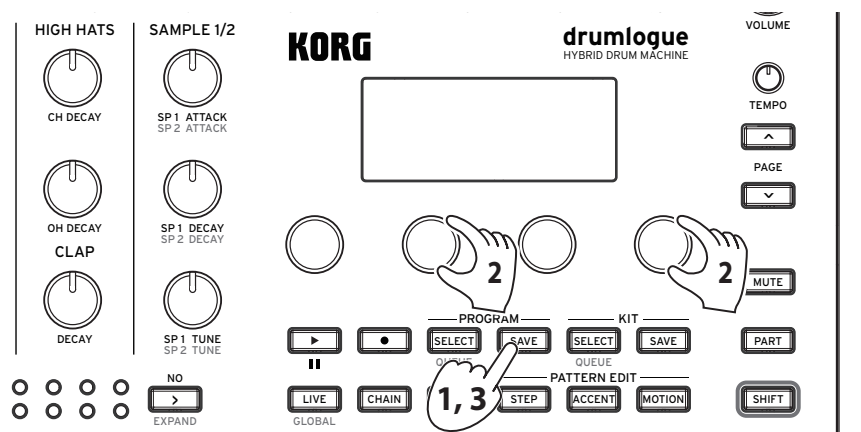

1. When you press the PROGRAM SAVE button, it enters the standby state to save a program, and the PROGRAM SAVE button blinks.
2. Turn Parameter knob 2 & 4, and select a program that you want to save.
3. When you press the PROGRAM SAVE button again, the drum kit will be saved with the program.

TIP Press the  (NO) button to cancel.

- ▲ To individually save a program and drum kit, turn off the global parameter "Save Kit with Program" setting ("OPERATIONS (Button 1)" p.44).
- ▲ Never turn off the power while Programs are being saved. Doing so may destroy the internal data.
- ▲ The program in the storage location is overwritten. Note that you cannot cancel the operation.



Using the Sequencer

Transport

Playing and stopping a pattern (During pattern edit)

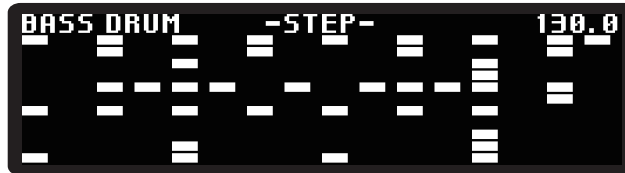
When you press the STEP button, the following is displayed.



As in Live mode, press the  (PLAY) button to play or stop the pattern. You can pause a pattern by pressing the  (PLAY) button while holding down the SHIFT button.

Changing the tempo

(→ p.13 "Changing the tempo")

Time and groove

To change the timescale for the clock or edit the number of steps in the pattern, turn the parameter knob while holding down the TIME button. You can also set each part by pressing the TIME button while holding down the PART button.

RATE [Global (only the part setting), 32nd, 16th, 8th]

Changes the playback speed of the pattern for the clock. The default is 16th. If the value is set to 8th, the speed is halved, and if set to 32nd, the speed is doubled.

TRIPLET [Global (only the part setting), OFF, ON]

Turn it on to increase the speed by 1.5 times triplets.

LENGTH [1...64]

Allows you to change the pattern length in steps.

Also, you can produce various groove feelings by applying the groove type that reproduces the swing and the playing style of a typical instrument to the pattern data. Press the TIME button while holding down the SHIFT button, and turn the parameter knob while holding down the TIME button. You can also set each part by pressing the TIME button while holding down the SHIFT button and the PART button.

TYPE [Global (only the part setting), Swing16, ..., CrescendoHalf]

Select the groove type. The groove type is a 16-step preset template that summarizes the timing and velocity change amount for each step.

Swing16: Gives regular swing in 16th note units. Even steps are slower and weaker, and odd steps are stronger.

Swing8: Gives regular swing in eighth note units. Makes the back beat to the beginning of the beat slow and weak, and the front beat strong.

ConstOffset: Evenly delays or strengthens all steps.

Conga1, 2, 3: This type simulates the performance of a conga.

Bongo1, 2, 3: This type simulates the performance of a bongo drum.

Cabasa1, 2: This type simulates the performance of a cabasa.

Claves1, 2: This type simulates the performance of claves.

Cowbell: This type simulates the performance of a cowbell.

Agogo1, 2: This type simulates the performance of an agogô.

Tambourine: This type simulates the performance of a tambourine.

Finger1, 2: Gives a bold and tricky swing similar to the sound you can create by finger drumming, and puts an emphasis on the beginning of the beat.

Lofi1, 2: Gives a laid-back sluggishness that slightly delays the beat in sections other than the beginning of the beat.

Baile1, 2: Gives a plunging groove that strongly accelerates to the rhythm of the dotted eighth notes.

OvalGroove: Gives an elliptical swing that accelerates toward the 1st and 3rd beats and decelerates toward the 2nd and 4th beats.

Syncopation: Gives a stronger accent to the 16th step compared to the beginning of the bar.

Crescendo: Gives a change that gradually strengthens and accelerates in 16 steps.

CrescendoHalf: Gives a change that gradually strengthens and accelerates in eight steps.

VELO **[-100%...100%]**

Sets the amount of change in the velocity strength of the step.

TIP If you select a negative value, you can obtain the opposite effect to the characteristics of the groove type you selected.

TIME **[-100%...100%]**

Sets the amount of change in the step timing.



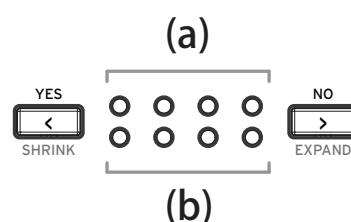

TIP If you select a negative value, you can obtain the opposite effect to the characteristics of the groove type you selected.

Changing the number of bars and steps (SHRINK button, EXPAND button)



(a) The LEDs on the top indicate the number of bars in the program (16 steps x 4), and the current position blinks according to the tempo.

(b) The LEDs on the bottom indicate the bars to be edited. Used for pattern editing.

If you press the  (YES) button or  (NO) button, you can change the bar to be edited (1 ... 4). You can also reduce the number of bars (SHRINK) by pressing the  (YES) button while holding down the SHIFT button, and increase the number of bars (EXPAND) by pressing the  (NO) button while holding down the SHIFT button.

TIP In Global mode, you can set how to increase the number of bars for the bar to EXPAND for the first time.

▲ The GLOBAL setting does not apply to bars that you have increased previously.

Editing a Pattern

STEP button (Step entry of notes)

Enter notes in a step. You can enter notes using buttons 1 to 16.

You can also edit the sound extensively for each step.

If you hold down buttons 1 to 16, the screen below appears. You can edit the target parameter by turning parameter knobs 1 to 4 while holding down the STEP button.



PROB. (PROBABILITY) [0%...100%]

Sets the probability that a step will sound.

ALTER. (ALTERNATE) [ALWAYS, ■□, □■, ■□□, ..., ■■■□■]

Sets the probability for that step to be played.

[■□□] means the step is only played on the first of three cycles, while [□■■■] means the step is played on the second and third of three cycles.

OFFSET [-50%...49%]

Sets the offset for the start point of the step.

ACCENT button (Adding an accent to each step)

Sets the accent for each step.

If you hold down buttons 1 to 16, the screen below appears. You can edit the target parameter by turning parameter knobs 1 to 4 while holding down the ACCENT button.



ACCENT [1...127]

Sets the accent in 127 steps.

TIP Each time you press buttons 1 to 16 several times, you can enter the velocity value of 32, 64, 96, or 127 as a shortcut.

RATCHET [OFF, 2, 3, 4]

Sets the number of times to hit the step repeatedly.

RAMP

[Flat, Fall, Rise, Random]

Sets the curve of RATCHET.

Flat: Produces a drum roll at the same volume.

Fall: Produces a drum roll while lowering the volume.

Rise: Produces a drum roll while raising the volume.

Random: Makes the volume of each drum roll random.

MOTION button (Setting the motion for each step)

Set the motion for each step. This unit is capable of recording all parameters for each step. During MOTION edit, you can record the value of the target parameter for each step by turning the kit control or parameter knobs 1 to 4 while holding down buttons 1 to 16.



Chain mode

In Chain mode, up to 16 programs can be connected and played in real time.

Use buttons 1 to 16 to register the program. Playback is performed in the order of 1 to 16.

Registering a program with CHAIN

1. Press the CHAIN button to enter Chain mode.



2. Press buttons 1 to 16 to display the program selection screen for each button. Buttons 1 to 16 directly correspond to CHAIN 1 to 16.
3. Turn the parameter knob to select a program in the same way as for the regular Program Select.
4. Press the PROGRAM SELECT button to add the program to CHAIN. Repeat steps 2 to 4 to add the program to CHAIN.
5. Press the  (PLAY) button to play the programs in the order specified by CHAIN.

TIP When you press the CHAIN button, "Set Queue" is displayed, and you can change the next program to be played.

Deleting a program from CHAIN

1. Press the CHAIN button to enter Chain mode.
2. Hold down buttons 1 to 16 corresponding to the order of CHAIN you want to delete; the following screen appears.

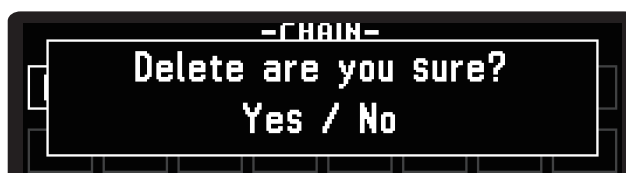

3. Press the (YES) button to execute deletion. To cancel deletion, press the (NO) button.

TIP Hold down the CHAIN button to delete all registered programs.

Deleting all the programs from CHAIN

1. If you hold down the CHAIN button in Chain mode, the following screen appears.



2. Press the (YES) button to execute deletion. To cancel deletion, press the (NO) button.

Loop mode

During pattern playback, you can specify the playback range in real time to loop, or playback only the specified steps.



MODE

[MOMENT, SELECT]

Sets the LOOP method. You can press any number of buttons.

MOMENT: LOOP is enabled while you are pressing one or more of buttons 1 to 16. LOOP is canceled when you release your finger from all of buttons 1 to 16.

SELECT: Of buttons 1 to 16, the button you pressed is set as the step to be looped. Press the button again to cancel LOOP.

TIP If you change to SELECT while pressing the button in MOMENT, LOOP is inherited.

TIP If you change from SELECT to MOMENT, the buttons selected in SELECT are canceled at once.

PLAY

[FORWARD, RAND]

Sets the playback order when multiple steps are selected.

FORWARD: Plays the step to be looped from buttons 1 to 16.

RAND: Randomly plays the step to be looped.

SPEED

[1/4, 1/2, 1X, 2X, 4X]

Sets the playback speed in Loop mode. You can select from 1/4 to four times the current tempo value.

RESUME

[SYNCED, FREE]

Sets the operation when LOOP is canceled.

SYNCED: Returns to the timing position of the pattern.

FREE: Continues playback from the position where LOOP is canceled.

TIP LOOP is not canceled even if the mode is switched during LOOP.

Using the SHIFT function

You can access various SHIFT functions of this unit by pressing buttons 1 to 16 while holding down the SHIFT button. There are many useful features for editing sequencer steps.

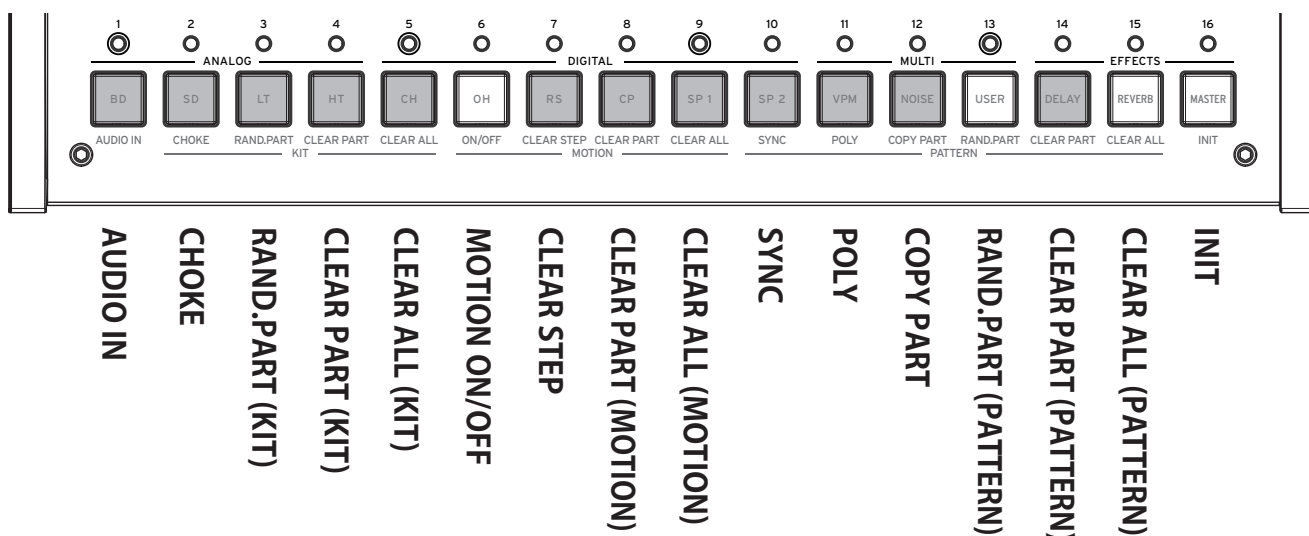

Usage example

For example, here is how to clear the steps in the CH (closed hi-hat) part.

1. First, select the part for which you want to use the SHIFT function. If you press button 5 while holding down the PART button, the CH part is selected.
2. While holding down the SHIFT button, execute the SHIFT function assigned to buttons 1 to 16. If you press button 14 while holding down the SHIFT button, "CLEAR PART" is executed, and CH disappears from the rhythm pattern.
3. If you press the same SHIFT function button while holding down the SHIFT button again, you can undo the operation (return to the previous state).

AUDIO IN (Button 1)

Makes settings for the sound source connected to the AUDIO IN jack.

LEVEL [-48.0dB...6.0dB]

Adjusts the volume of the external sound source.

ROUTE (ROUTING) [NONE, DELAY, REVERB, MASTER, SIDECH, OUTPUT]

Sets the routing. You can output the sound from OUTPUT as it is, apply an effect, or apply a ducking effect by routing to the SIDECHAIN input of the effect.

CHOKER (Button 2)

Sets the priority of the part to be played when multiple parts are triggered at the same time. For example, if you do not play OH and CH at the same time, it makes a sound similar to that of a real hi-hat. Select the part to be set using buttons 1 to 13.

GROUP

[OFF, 1...4]

Sets the group to apply the priority.

Each time you press buttons 1 to 13, the part switches between OFF and 1.

PRIORITY

[LOW, MID, HIGH]

Sets the priority of the part.

RAND.PART (KIT) (Button 3)

Sets the parameters of the current part (various parameters and SOUND SELECT on the PARAMETERS page) with random values. If you press the button several times, the parameter is set with a different random value each time.

CLEAR PART (KIT) (Button 4)

Resets the tone of the current part. Press the button again to undo the operation (restores the parameter state that existed before resetting).

⚠ If you switch the target part before executing undo, you cannot undo.

CLEAR ALL (KIT) (Button 5)

Resets the tone of all parts. Press the button again to undo the operation (restores the parameter state that existed before resetting).

ON/OFF (Button 6)

Sets the motion sequence on or off.

CLEAR STEP (Button 7)

Resets the motion of the current part for each step. Press the button again after resetting to undo the operation (restores the parameter state that existed before resetting).

CLEAR PART (MOTION) (Button 8)

Resets all motions for the current part. Press the button again after resetting to undo the operation (restores the parameter state that existed before resetting).

⚠ If you switch the target part before executing undo, you cannot undo.

CLEAR ALL (MOTION) (Button 9)

Resets the motion set for all parts. Press the button again after resetting to undo the operation (restores the parameter state that existed before resetting).

SYNC (Button 10)

Returns the playback position of the current part to the first step.

POLY (Button 11)

Makes each part independent without aligning the beginning of pattern playback with the longest pattern part.

COPY PART (Button 12)

Copies and pastes the pattern data. The pattern data of the current part is copied, and the LEDs of buttons 1 to 13 of the pasted part blink. To paste the pattern data, press the button of the part you want to paste.

RANDOM PART (PATTERN) (Button 13)

Randomly enter notes at each step of the current part.

CLEAR PART (PATTERN) (Button 14)

Resets all pattern data for the current part.

Press the button again to undo the operation (restores the parameter state that existed before resetting).

⚡ If you switch the target part before executing undo, you cannot undo.

CLEAR ALL (PATTERN) (Button 15)

Resets the pattern data for all parts.

Press the button again to undo the operation (restores the parameter state that existed before resetting).

INIT (Button 16)

Initializes all the current programs and drum kits. They are only initialized and not saved. Save them as needed.

Press the button again to undo the operation (restores the parameter state that existed before resetting).

⚡ If you switch the target part before executing undo, you cannot undo.

Sound Source Parameters

Analog sound source parts (BD, SD, LT, HT)

BD (Bass drum)

Control knob

DECAY [0...1023]

Adjusts the sounding length of the drumhead.
The greater the value, the longer the sound.

TUNE [0...1023]

Adjusts the pitch of the bass drum.

DRIVE [0...1023]

Adjusts the distortion amount of the bass drum. A fat sound is created by moderately distorting the bass drum.

SOUND SELECT

TRANSIENT [01..16]

Select a bass drum transient.

A short PCM sample is layered on the BD analog sound source, which is referred to as a transient. A transient allows you to change the character of the BD attack tone.

PARAMETERS

SWEEP [0.0%...100.0%]

Adjusts the level of the sweep (which changes the pitch when triggered).

SW.TIME [0.0%...100.0%]

Adjusts the sweep speed.

HOLD [0...3]

Sets the time period to keep sounding at a constant volume.

ATTACK [0.0%...100.0%]

Adjusts the level of the transient sound.

CUTOFF [L0.0%...L99.5%, THRU, H0.5%...H100.0%]

Adjusts the cutoff frequency of the filter.

You can select the low-pass filter, no filter (THRU), or the high-pass filter.

RESON(CUTOFF RESONANCE) [0.0%...100.0%]

Adjusts the cutoff resonance of the filter.

- ▲ If you increase the value, the filter oscillates, which may cause the sound to continue.

MIX/ROUTE

PAN [L100%...L1%, C, R1%...R100%]

Adjusts the pan pot (left and right stereo localization).

DELAY [0.0%...100.0%]

Adjusts the feed amount of the delay effect.

REVERB [0.0%...100.0%]

Adjusts the feed amount of the reverb effect.

MASTER [ON, BYPASS]

Sets the master effect to On or Bypass.

SIDECH (SIDECHAIN) [0.0%...100.0%]

Adjusts the feed amount of the SIDECHAIN pass.

- TIP** The master effect has an input that is referred to as the SIDECHAIN pass. For example, in COMPRESSOR, you can use the SIDECHAIN pass to obtain a ducking effect.

SD (Snare drum)

Control knob

DECAY [0...1023]

Adjusts the sounding length of the drumhead. The greater the value, the longer the sound.

TUNE [0...1023]

Adjusts the pitch. The greater the value, the higher the sound.

SNAP.DEC (SNAPPY DECAY) [0...1023]

Adjusts the snappy sound length of the snare drum.

SOUND SELECT

SNAPPY TYPE [01..09]

Select the snappy tone of the snare drum.

PARAMETERS

TONE [0.0%...100.0%]

Adjusts the tuning deviation of the two drumheads.

SNAP.LV (SNAPPY LEVEL) [0.0%...100.0%]

Adjusts the snappy volume of the snare drum.

CUTOFF [L0.0%...L99.5%, THRU, H0.5%...H100.0%]

Adjusts the cutoff frequency of the filter.

You can select the low-pass filter, no filter (THRU), or the high-pass filter.

RESON (CUTOFF RESONANCE) [0.0%...100.0%]

Adjusts the cutoff resonance of the filter.

- ▲ If you increase the value, the filter oscillates, which may cause the sound to continue.

MIX/ROUTE

PAN [L100%...L1%, C, R1%...R100%]

Adjusts the pan pot (left and right stereo localization).

SPREAD [<100%...<1%, 0, >1%...>100%]

Adjusts the spread of sound (stereo feeling).

DELAY [0.0%...100.0%]

Adjusts the feed amount of the delay effect.

REVERB [0.0%...100.0%]

Adjusts the feed amount of the reverb effect.

MASTER [ON, BYPASS]

Sets the master effect to On or Bypass.

SIDECH (SIDECHAIN) [0.0%...100.0%]

Adjusts the feed amount of the SIDECHAIN pass.

LT, HT (Low tom, High tom)

Control knob

LT (HT) DECAY [0...1023]

Adjusts the sounding length of the low-tom or high-tom drumhead.

The greater the value, the longer the sound.

LT (HT) TUNE [0...1023]

Adjusts the pitch of the low tom or high tom. The greater the value, the higher the sound.

LT (HT) DETUNE [0...1023]

Adjusts the tuning deviation between the two drumheads for low tom or high tom.

SOUND SELECT

LAYER [01...10]

Select the layer sound type of low tom or high tom.

A short PCM sample is layered on the low tom and high tom analog sound sources, allowing you to change the tone character of the attack.

PARAMETERS

SWEEP [0.0%...100.0%]

Adjusts the level of the sweep (which changes the pitch when triggered) of low tom or high tom.

ATTACK [0.0%...100.0%]

Adjusts the level of the layered sound of low tom or high tom.

CUTOFF [L0.0%...L99.5%, THRU, H0.5%...H100.0%]

Sets the cutoff frequency of the filter of low tom or high tom.

You can select the low-pass filter, no filter (THRU), or the high-pass filter.

RESON (CUTOFF RESONANCE) [0.0%...100.0%]

Sets the cutoff resonance of the filter of low tom or high tom.

- ▲ If you increase the value, the filter oscillates, which may cause the sound to continue.

DRIVE [OFF, LOW, HIGH]

Sets the distortion amount of low tom or high tom. A fat sound is created by moderately distorting low tom or high tom.

MIX/ROUTE

PAN [L100%...L1%, C, R1%...R100%]

Adjusts the pan pot (left and right stereo localization).

DELAY [0.0%...100.0%]

Adjusts the feed amount of the delay effect.

REVERB [0.0%...100.0%]

Adjusts the feed amount of the reverb effect.

MASTER [ON, BYPASS]

Sets the master effect to On or Bypass.

SIDECH (SIDECHAIN) [0.0%...100.0%]

Adjusts the feed amount of the SIDECHAIN pass.

Digital sound source parts (CH, OH, RS, CP, SP1, SP2)

CH, OH, RS, CP (Closed hi-hat, Open hi-hat, Rimshot, Clap)

Control knob

CH DECAY [0...1023]

Adjusts the sounding length of the closed hi-hat. The greater the value, the longer the sound.

OH DECAY [0...1023]

Adjusts the sounding length of the open hi-hat. The greater the value, the longer the sound.

CP DECAY [0...1023]

Adjusts the clap sounding length. The greater the value, the longer the sound.

SOUND SELECT

BANK [CH, OH, RS, CP, MISC, USER, EXP]

Select the sound type. The sample sound sources are classified into the following banks.

CH: Closed hi-hat sample

OH: Open hi-hat sample

RS: Rimshot sample

CP: Clap sound sample

MISC: Various other samples

USER*: User-created sample

EXP*: Expansion pack sample

*User-installed samples can be stored in the USER and EXP banks (→ p.52 "Loading USER SAMPLE").

SAMPLE [01..16/64/128]

Select a sample sound. The number of sample sounds varies depending on the bank you select.

CH, OH, RS, CP: Max. 16 samples

MISC: Max. 64 samples

EXP, USER: Max. 128 samples

PARAMETERS

TUNE [-24.00...0...+24.00]

Sets the pitch.

ATTACK (other than RS) [0.0%...100.0%]

Sets the attack time. The greater the value, the slower the sound rises.

DECAY (RS only) [0.0%...100.0%]

Sets the decay time. The greater the value, the longer the sound.

START [0.0%...100.0%]

Sets the start position of sample playback.

END [0.0%...100.0%]

Sets the end position of sample playback.

CUTOFF [L0.0%...L99.5%, THRU, H0.5%...H100.0%]

Sets the cutoff frequency of the filter.

You can select the low-pass filter, no filter (THRU), or the high-pass filter.

RESON (CUTOFF RESONANCE) [0.0%...100.0%]

Sets the cutoff resonance of the filter.

- ▲ If you increase the value, the filter oscillates, which may cause the sound to continue.

REDUX [0.0%...100.0%]

Adjusts the distortion amount due to bit reduction.

DRIVE [0.0%...100.0%]

Sets the distortion amount of the sound source. A fat sound is created by moderately distorting the sound source.

MIX/ROUTE

PAN [L100%...L1%, C, R1%...R100%]

Adjusts the pan pot (left and right stereo localization).

SPREAD [<100%...<1%, 0, >1%...>100%]

Adjusts the spread of sound (stereo feeling).

DELAY [0.0%...100.0%]

Adjusts the feed amount of the delay effect.

REVERB [0.0%...100.0%]

Adjusts the feed amount of the reverb effect.

MASTER [ON, BYPASS]

Sets the master effect to On or Bypass.

SIDECH (SIDECHAIN) [0.0%...100.0%]

Adjusts the feed amount of the SIDECHAIN pass.

SP1, SP2 (Sample sound sources 1, 2)

Control knob

SP1 (SP2) ATTACK [0...1023]

Adjusts the attack time of sample sound source 1 (or 2). The greater the value, the slower the sound rises.

SP1 (SP2) DECAY [0...1023]

Adjusts the decay time of sample sound source 1 (or 2). The greater the value, the longer the sound.

SP1 (SP2) TUNE [-24.00...0.00...+24.00]

Adjusts the pitch of sample sound source 1 (or 2). The greater the value, the higher the sound.

SOUND SELECT

BANK [CH, OH, RS, CP, MISC, USER, EXP]

(Same as CH/OH/RS/CP)

SAMPLE [01..16/64/128]

(Same as CH/OH/RS/CP)

PARAMETERS

START [0.0%...100.0%]

Sets the start position of sample playback.

END [0.0%...100.0%]

Sets the end position of sample playback.

CUTOFF [L0.0%...L99.5%, THRU, H0.5%...H100.0%]

Sets the cutoff frequency of the filter.

You can select the low-pass filter, no filter (THRU), or the high-pass filter.

RESON (CUTOFF RESONANCE) [0.0%...100.0%]

Sets the cutoff resonance of the filter.

- ⚠ If you increase the value, the filter oscillates, which may cause the sound to continue.

REDUX [0.0%...100.0%]

Adjusts the distortion amount due to bit reduction.

DRIVE [0.0%...100.0%]

Sets the distortion amount of the sound source. A fat sound is created by moderately distorting the sound source.

MIX/ROUTE

PAN [L100%...L1%, C, R1%...R100%]

Adjusts the pan pot (left and right stereo localization).

SPREAD [<100%...<1%, 0, >1%...>100%]

Adjusts the spread of sound (stereo feeling).

DELAY [0.0%...100.0%]

Adjusts the feed amount of the delay effect.

REVERB [0.0%...100.0%]

Adjusts the feed amount of the reverb effect.

MASTER [ON, BYPASS]

Sets the master effect to On or Bypass.

SIDECH (SIDECHAIN) [0.0%...100.0%]

Adjusts the feed amount of the SIDECHAIN pass.

Multi-sound source parts (VPM, NOISE, USER)

VPM (Variable Phase Modulation)

SOUND SELECT

PRESET [Default, Oct., Half, Fourth, Air, Creep, Throat, Harsh]

Select the basic preset for the VPM sound source.

If you select a preset, seven parameters shown in the PARAMETERS page are changed, excluding NOTE.

PARAMETERS

NOTE [C-1...G9]

Sets the sound pitch.

INDEX [0.0%...100.0%]

Adjusts how much phase modulation is applied.

RATIO [1/4, 1/2, 3/4, 1x, 2x...16x]

Adjusts the phase modulation frequency as a percentage of NOTE.

NOISE [0.0%...100.0%]

Adjusts the depth of noise modulation.

EG [AR, ASR, GATE]

Select the type of EG (Envelope Generator).

AR: AR-type EG (Attack, Release)

ASR: ASR-type EG (Attack, Sustain, Release)

GATE: GATE-type EG (On/Off only)

ATTACK [0.0%...100.0%]

Sets the attack time. The greater the value, the slower the sound rises.

RELEASE [0.0%...100.0%]

Sets the release time. The greater the value, the longer the sound.

IDX MOD [-100%...0%...100%]

Adjusts how much EG modulation is applied to the INDEX parameter.

MIX/ROUTE

PAN [L100%...L1%, C, R1%...R100%]

Adjusts the pan pot (left and right stereo localization).

SPREAD [<100%...<1%, 0, >1%...>100%]

Adjusts the spread of sound (stereo feeling).

DELAY [0.0%...100.0%]

Adjusts the feed amount of the delay effect.

REVERB [0.0%...100.0%]

Adjusts the feed amount of the reverb effect.

MASTER [ON, BYPASS]

Sets the master effect to On or Bypass.

SIDECH (SIDECHAIN) [0.0%...100.0%]

Adjusts the feed amount of the SIDECHAIN pass.

NOISE

SOUND SELECT

ALGO [LPF 2, LPF 4, BPF 2, BPF 4, HPF 2, HPF 4, DECIM]

Select the noise sound type. The low pass (LPF), band pass (BPF), and high pass (HPF) provide two types of filters: -12dB/oct and -24dB/oct. DECIM is the noise source that uses sampling rate decimation.

PARAMETERS

COLOR [0.0%...100.0%]

Adjusts the darkness and brightness of the tone. The lower the parameter value, the darker the tone.

PEAK (other than DECIM) [0.0%...100.0%]

Adjusts the peak of the filter.

ATTACK [0.0%...100.0%]

Sets the attack time. The higher the value, the slower the rises of the sound.

RELEASE [0.0%...100.0%]

Sets the release time. The higher the value, the longer the sound.

MIX/ROUTE

PAN [L100%...L1%, C, R1%...R100%]

Adjusts the pan pot (left and right stereo localization).

SPREAD [<100%...<1%, 0, >1%...>100%]

Adjusts the spread of sound (stereo feeling).

DELAY [0.0%...100.0%]

Adjusts the feed amount of the delay effect.

REVERB [0.0%...100.0%]

Adjusts the feed amount of the reverb effect.

MASTER [ON, BYPASS]

Sets the master effect to On or Bypass.

SIDECH (SIDECHAIN) [0.0%...100.0%]

Adjusts the feed amount of the SIDECHAIN pass.

USER

SOUND SELECT

SELECT [---, Nano, ...]

Select the user synth to load.

At the time of shipment from the factory, the user synth "Nano" developed in collaboration with Sinevibes is installed on this unit.

TIP Parameters vary depending on the user synth. For explanations about functions other than nano, refer to the manual for each user synth.

*PARAMETERS * For Nano*

NOTE [C-1...C5]

Sets the sound pitch.

WAVE [2x Saw, 2x Sqr, 2x Tri, Saw+Sqr, Saw+Tri, Sqr+Tri, Ring 1..3]

Select the waveforms of two oscillators.

DETUNE [-24.0...+24.0]

Adjusts the pitch shift between the main oscillator and the sub oscillator.

BALANCE [0%...100%]

Adjusts the volume balance between the two oscillators.

FILTER [LP, HP, BP]

Select the filter type. There are three types of filters: low pass, high pass, and band pass.

CUTOFF [0%...100%]

Adjusts the cutoff frequency of the filter.

KEYTRACK [0%...100%]

Adjusts the key tracking effect on the filter cutoff.

RESON (RESONANCE) [0%...100%]

Adjusts the cutoff resonance of the filter.

EG TYPE [D, A1D, A2D]

Select the type of EG (Envelope Generator).

D: Type with the fixed attack and adjustable decay only

A1D: Adjusts the attack and decay at the same time. The attack time and decay time are the same.

A2D: Adjusts the attack and decay at the same time. The decay time is twice the length of the attack time.

EG TIME **[0%...100%]**

Adjusts the EG time. The greater the value, the slower the change in EG.

PITCH EG **[-100%...100%]**

Adjusts the amount of EG applied to the pitch.

CUT. EG **[-100%...100%]**

Adjusts the amount of EG applied to the filter cutoff.

LFO TYPE **[Tri, Saw, Sqr, Trap, Peak, S&H, Random]**

Select the LFO (Low Frequency Oscillator) waveform.

LFO FREQ **[0%...100%]**

Adjusts the LFO cycle.

PITCH LFO **[-100%...100%]**

Adjusts the amount of LFO applied to the pitch.

CUT. LFO **[-100%...100%]**

Adjusts the amount of LFO applied to the filter cutoff.

MIX/ROUTE

PAN **[L100%...L1%, C, R1%...R100%]**

Adjusts the pan pot (left and right stereo localization).

SPREAD **[<100%...<1%, 0, >1%...>100%]**

Adjusts the spread of sound (stereo feeling).

DELAY **[0.0%...100.0%]**

Adjusts the feed amount of the delay effect.

REVERB **[0.0%...100.0%]**

Adjusts the feed amount of the reverb effect.

MASTER **[ON, BYPASS]**

Sets the master effect to On or Bypass.

SIDECH (SIDECHAIN) **[0.0%...100.0%]**

Adjusts the feed amount of the SIDECHAIN pass.

Effects (DELAY, REVERB, MASTER)

This unit provides three effect sections in which DELAY and REVERB are placed in an independent send bus, and MASTER is placed inline in the final mix bus.

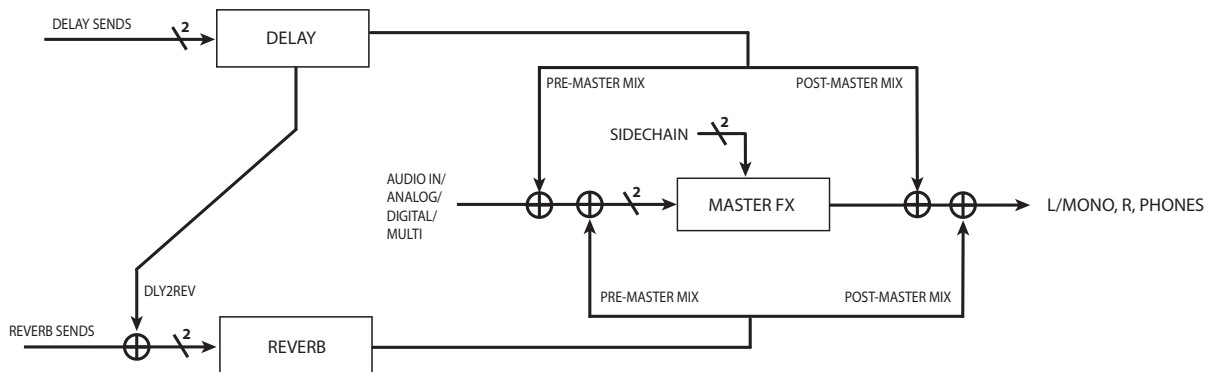

DELAY

SOUND SELECT

SELECT [---, Stereo, Mono, Tape, Stereo BPM, Mono BPM, Tape BPM, ...*]

Select the type of delay effect.

Stereo: This is a stereo delay that allows you to set the left and right sound spreads and the routing type.

Mono: This is a straight-type monaural delay.

Tape: Simulates a tape echo.

Stereo BPM: This is a stereo delay of which the delay time period is synchronized with the TEMPO setting.

Mono BPM: This is a monaural delay of which the delay time period is synchronized with the TEMPO setting.

Tape BPM: Tape echo of which the delay time period is synchronized with the TEMPO setting.

* You can also add a delay effect created with the logue SDK (→ p.52 "Loading user synth and effects").

*PARAMETERS - For Stereo/Stereo BPM**

TIME [0.0%...100.0%]/[1/64, 1/48, ... 3/4, 1]

Adjusts the delay time.

* For Stereo BPM, set TIME as the relative value for the BPM value of the tempo.

FB (FEEDBACK) [0.0%...100.0%]

Adjusts the delay feedback amount.

SPREAD [L100%...L1%, C, R1%...R100%]

Adjusts the delay time period difference between the left and right delay lines.

FILTER [---, LP, HP]

Select the filter type for feedback.

You can select the low-pass filter or the high-pass filter.

CUTOFF [0.0%...100.0%]

Sets the cutoff frequency of the filter.

SAT. (SATURATION) [0.0%...100.0%]

Sets the saturation level of the filter.

ROUTE [NORMAL, CROSSED, P-PONG]

Sets the feedback signal route.

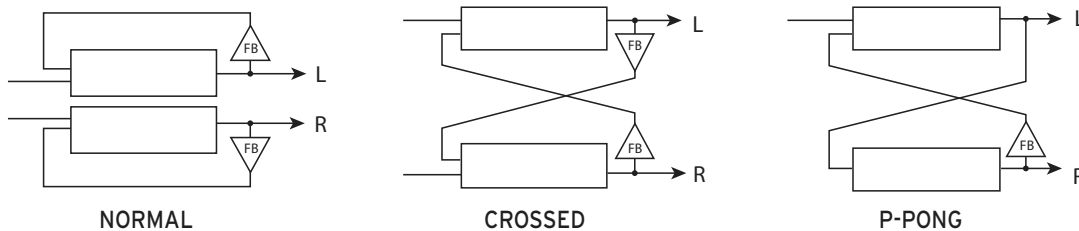

PARAMETERS - For Mono/Mono BPM

TIME [0.0%...100.0%]/[1/64, 1/48, ... 3/4, 1]

Adjusts the delay time.

* For Mono BPM, set TIME as the relative value for the BPM value of the tempo.

FB (FEEDBACK) [0.0%...100.0%]

Adjusts the delay feedback amount.

FILTER [---, LP, HP]

Select the filter type for feedback.

You can select the low-pass filter or the high-pass filter.

CUTOFF [0.0%...100.0%]

Sets the cutoff frequency of the filter.

SAT. (SATURATION) [0.0%...100.0%]

Sets the saturation level of the filter.

PARAMETERS - For Tape/Tape BPM

TIME [0.0%...100.0%]/[1/64, 1/48, ... 3/4, 1]

Adjusts the delay time.

* For Tape BPM, set TIME as the relative value for the BPM value of the tempo.

FB (FEEDBACK) [0.0%...100.0%]

Adjusts the delay feedback amount.

MOD (MODULATION) [0%...100%]

Adjusts the amount of the modulation applied to the delay time period.

TRACKING [0.0%...100.0%]

Adjusts the amount that simulates the tracking sensitivity of the tape head.

TOPE [0.0%...100.0%]

Adjusts the sound quality of the delay effect.

SAT. (SATURATION) [0.0%...100.0%]

Sets the saturation level of the filter.

ROUTE [NORMAL, CROSSED, P-PONG]

Sets the feedback signal route.

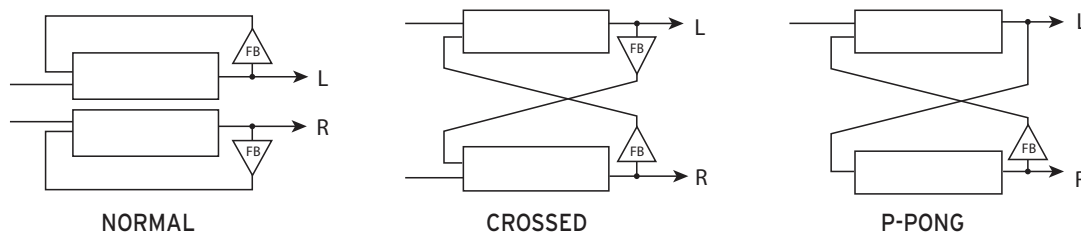

MIX/ROUTE

LEVEL [0.0%...100.0%]

Adjusts the amount of the delay effect.

RETURN [PRE, POST]

Select whether to put the reverb effect before or after the master effect.

REVERB [0.0%...100.0%]

Adjusts the amount to feed from the delay to the reverb.

REVERB

SOUND SELECT

SELECT [---, Room, Hall, Space, Riser, Submarine, ...*]

Select the type of reverb effect.

Room: A reverb inspired by the reverberating sound created in a small room.

Hall: A reverb inspired by the reverberating sound created in a concert hall or ensemble hall.

Space: An unstable reverb with a slow reverberating sound.

Riser: A glittering reverb with a reverberating sound that spreads an octave above.

Submarine: A deep reverb with a reverberating sound that extends an octave below.

* You can also add reverb effects created with the logue SDK (→ p.52 "Loading user synth and effects").

PARAMETERS

TIME [0.0%...100.0%]

Adjusts the reverb time.

INPUT [0.0%...100.0%]

Adjusts the signal level of the reverb input.

BRIGHT [0.0%...100.0%]

Adjusts the tone (brightness) of the reverb.

RISE (Riser only) [0.0%...100.0%]

Adjusts the pitch-shifted reverb sound signal on the octave.

DIVE (Submarine only) [0.0%...100.0%]

Adjusts the pitch-shifted reverb sound signal below the octave.

MIX/ROUTE

LEVEL [0.0%...100.0%]

Adjusts the amount of the reverb effect.

RETURN [PRE, POST]

Select whether to put the reverb effect before or after the master effect.

MASTER (Master Effect)

SOUND SELECT

SELECT [---, Compressor, Filter, Boost, EQ Three, ...*]

Select the type of master effect.

Compressor: A basic compressor that raises the sound pressure.

Filter: A multi-mode filter with cutoff resonance.

Boost: A booster with adjustable center frequency and saturation.

EQ Three: A 3-band equalizer with adjustable crossover frequency.

* You can also add master effects created with the logue SDK (→ p.52 "Loading user synth and effects").

PARAMETERS - For Compressor

THRESH (THRESHOLD) [-64.0dB...0.0dB]

Adjusts the threshold at which the compressor begins to apply.

ATTACK [0.5ms...100ms]

Adjusts the attack time that the compressor responds to.

RELEASE **[50ms...1s]**

Adjusts the release time of the compressor.

RATIO **[1...10]**

Adjusts the compression ratio of the compressor.

MAKEUP **[0.00dB...8.00dB]**

You can increase the overall gain of the signal to compensate for compression.

KNEE **[0.00dB...8.00dB]**

Adjusts the smoothness at the beginning of the compressor effect.

SIDECH (SIDECHAIN) **[OFF, ON]**

If you want to enable the input signal from SIDECHAIN, set this parameter to ON.

WET **[0.0%...100.0%]**

Adjusts the ratio of effect sounds. The greater the value, the more the signal is compressed.

PARAMETERS - For Filter

MODE **[THRU, LPF 2, LPF 4, BPF 2, BPF 4, HPF 2, HPF 4]**

Select Filter mode.

There are six types in total, two types each for low pass, band pass, and high pass.

SATURATE **[0.0%...100.0%]**

Adjusts the saturation amount of the filter.

RESON (RESONANCE) **[0.0%...100.0%]**

Adjusts the resonance of the filter.

CUTOFF **[0.0%...100.0%]**

Adjusts the cutoff frequency of the filter.

PARAMETERS - For Boost

CENTER **[0.0%...100.0%]**

Adjusts the center frequency you want to boost.

WIDTH **[0.0%...100.0%]**

Adjusts the frequency bandwidth from the center frequency you want to boost.

SATURATE **[0.0%...100.0%]**

Adjusts the saturation amount of the booster.

BOOST **[0.0dB...12.00dB]**

Adjusts the boost amount. You can increase up to 12 dB.

PARAMETERS - For EQ Three

LOW **[-64.0dB...6.0dB]**

Adjusts the boost/cut amount in the low range.

MID **[-64.0dB...6.0dB]**

Adjusts the boost/cut amount in the mid range.

HIGH **[-64.0dB...6.0dB]**

Adjusts the boost/cut amount in the high range.

GAIN **[-6.0dB...6.0dB]**

Adjusts the gain of the entire input signal.

LOW/MID **[0.0%...100.0%]**

Adjusts the crossover frequency from the low range to the mid range.

MID/HIGH **[0.0%...100.0%]**

Adjusts the crossover frequency from the mid range to the high range.

SLOPE **[12dB, 24dB]**

Select the equalizer curve. 24dB is a steep curve.

Global Parameters

Press the LIVE button while holding down the SHIFT button to enter Global mode. In Global mode, you can make settings related to the input/output and hardware of this unit.

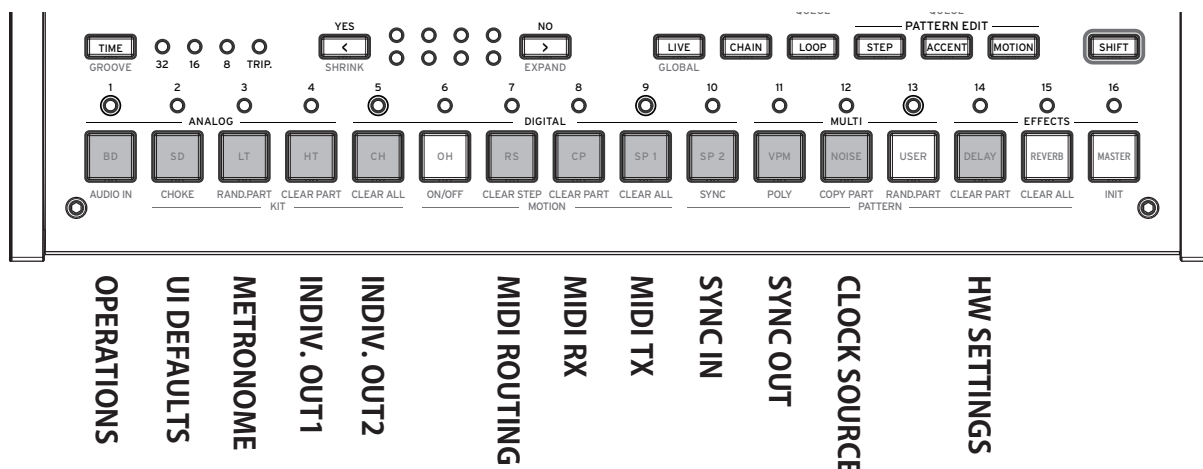

OPERATIONS (Button 1)

QUEUE (QUEUE MODE) [BAR, SEQ]

If you load a program or drum kit (QUEUE operation) while holding down the SHIFT button during pattern playback, set the timing for switching between the program and drum kit.

BAR: The next program or drum kit is loaded when the bar changes.

SEQ: After the previous rhythm pattern is played back to the last step, the next program or drum kit is loaded.

SAVE KIT (SAVE KIT WITH PROGRAM) [OFF, ON]

When you save the program, set whether to save the drum kit being edited at the same time.

OFF: Saves only the bank and kit number of the drum kit you want to use when you save the program.

ON: Saves the parameters of the drum kit you are editing when you save the program.

- ⚠ The drum kit in use is overwritten. Be careful when using a single drum kit with multiple programs.

TEMPO [PROG, LOCK]

Set whether to use the tempo specified for each program or to inherit the current tempo.

PROG: Uses the tempo specified for each program. The tempo changes when you load the program.

LOCK: The current tempo is maintained even if the program is switched.

QUANT (QUANTIZE) [NONE, 32ND, 16TH, 8TH]

When real-time recording is performed, the rhythm is quantized with the accuracy specified here.

NONE: The input timing is recorded as it is without any quantization.

32ND, 16TH, 8TH: Quantizes the input timing deviation with the fineness of the 32nd, 16th, and 8th notes, respectively. The deviated input is recorded on the closer one of the previous and next inputs.

UI DEFAULTS (Button 2)

PRM DISP (PARAMETER DISPLAY) [NORMAL, ALL]

NORMAL: Shows only key information such as the name of the program or drum kit, SELECT/SAVE, etc. on the display.

ALL: Pops up the value when you operate the kit control or parameter knob, in addition to the display in NORMAL.

KNOB MODE [JUMP, CATCH]

The front panel knobs can operate in one of two modes:

JUMP: When you turn the knob, the parameter value will jump to the value indicated by the knob. Since this makes it easy to hear the results while editing, we recommend that you use this setting.

CATCH: Turning the knob will not change the parameter value until the knob position matches the stored value. We recommend that you use this setting when you don't want the sound to change abruptly, such as while performing.

EXPAND [BLANK, COPY]

Press the EXPAND ( button while holding down the SHIFT button) to set options for increasing the number of bars for the first time.

BLANK: Adds a blank bar.

COPY: Adds a copy of the last bar.

METRONOME (Button 3)

SOUND [OFF, CLICK, BLEEP]

Turns the metronome on and off, and sets tone.

OFF: Turns the metronome off.

CLICK: Outputs an electronic sound that makes a clicking sound.

BLEEP: Outputs an electronic beeping sound.

MODE [ALWAYS, REC]

Makes the settings to operate the metronome.

ALWAYS: The metronome always sounds.

REC: The metronome sounds only during real-time recording.

OUTPUT [MAIN+HP, HP]

Sets the destination for the output of the metronome sound.

MAIN+HP: The metronome sound is output to both the main OUTPUT and headphone output.

HP: The metronome sound is only output to the headphones. It is not output to OUTPUT.

INDIV. OUT1 (Button 4)

OUT 1 [BD, SD, LT, HT, CH, OH, RS, CP, SP1, SP2, MULTI]

Sets the part to be output from the AUDIO OUT1 jack on the rear panel.

OUT 2 [BD, SD, LT, HT, CH, OH, RS, CP, SP1, SP2, MULTI]

Sets the part to be output from the AUDIO OUT2 jack on the rear panel.

OUT 3 [BD, SD, LT, HT, CH, OH, RS, CP, SP1, SP2, MULTI]

Sets the part to be output from the AUDIO OUT3 jack on the rear panel.

OUT 4 [BD, SD, LT, HT, CH, OH, RS, CP, SP1, SP2, MULTI]

Sets the part to be output from the AUDIO OUT4 jack on the rear panel.

INDIV. OUT2 (Button 5)

MUTE 1 [OFF, ON]

Turn this ON to mute the part output to the AUDIO OUT1 jack from the AUDIO OUT L/MONO, AUDIO OUT R, or headphone output.

MUTE 2 [OFF, ON]

Turn this ON to mute the part output to the AUDIO OUT2 jack from the AUDIO OUT L/MONO, AUDIO OUT R, or headphone output.

MUTE 3 [OFF, ON]

Turn this ON to mute the part output to the AUDIO OUT3 jack from the AUDIO OUT L/MONO, AUDIO OUT R, or headphone output.

MUTE 4 [OFF, ON]

Turn this ON to mute the part output to the AUDIO OUT4 jack from the AUDIO OUT L/MONO, AUDIO OUT R, or headphone output.

MIDI ROUTING (Button 7)

CH [1...16, 1-12, 2-13...5-16, 6-1..16-11]

Sets the MIDI channel used for MIDI sending/receiving. In addition to single channels 1 to 16, you can assign 11 parts to different MIDI channels (→ p.57 "MIDI Implementation Chart").

ROUTE [USB+MIDI, USB]

MIDI signals can be sent and received via the MIDI and USB connectors, or by the USB connector alone.

USB+MIDI: MIDI messages are received via the USB B connector and the MIDI IN con-

nector; messages are transmitted from the USB B connector and the MIDI OUT connector.
USB: MIDI messages will be transmitted and received only via the USB B connector.

MIDI RX (Button 8)

PRG CHG (PROGRAM CHANGE) [OFF, ON]

Selects whether MIDI program change messages will be received. Turn this ON when receiving messages.

CC (CONTROL CHANGE) [OFF, ON]

Selects whether MIDI control change messages will be received. Turn this ON when receiving messages.

TRANSP (MIDI TRANSPORT) [OFF, ON]

A filter to receive MIDI transport messages such as MIDI start/stop. Turn this ON when receiving messages.

MIDI TX (Button 9)

PRG CHG (PROGRAM CHANGE) [OFF, ON]

Selects whether MIDI program change messages will be transmitted. Turn this ON when sending messages.

CC (CONTROL CHANGE) [OFF, ON]

Selects whether MIDI control change messages will be transmitted. Turn this ON when sending messages.

TRANSP (MIDI TRANSPORT) [OFF, ON]

A filter to send MIDI transport messages such as MIDI start/stop. Turn this ON when sending messages.

SYNC IN (Button 10)

UNIT (SYNC IN UNIT) [8TH, 16TH]

The Sync In Units determine how much the Sequencer will advance with each pulse received via the SYNC IN jack.

8TH: The Sequencer will advance one eighth note for each pulse.

16TH: The Sequencer will advance one sixteenth note for each pulse.

POLAR [RISE, FALL]

In order to achieve synchronization with other units, the polarity of the SYNC IN jack may need to be changed.

RISE: The drumlogue will sync to the pulse as it rises to its crest (the highest point) of the waveform.

FALL: The drumlogue will sync to the pulse as it falls to its trough (the lowest point) of the waveform.

SYNC OUT (Button 11)

UNIT (SYNC OUT UNIT) [8TH, 16TH]

The Sync Out Units determine how far the Sequencer needs to advance in order to generate a pulse via the SYNC OUT jack.

8TH: A pulse will be outputted for every eighth note.

16TH: A pulse will be outputted for every sixteenth note.

POLAR [RISE, FALL]

In order for other units to correctly sync with the drumlogue, the polarity of the SYNC OUT jack may need to be changed.

RISE: The drumlogue will create a sync pulse as it rises to its crest (the highest point) of the waveform.

FALL: The drumlogue will create a sync pulse as it falls to its trough (the lowest point) of the waveform.

CLOCK SOURCE (Button 12)

SOURCE [AUTO, INT., USB, MIDI]

Many features of the drumlogue can be sync'd to the tempo or BPM.

AUTO: When there is no input, the sequencer synchronizes with the internal clock. When there is an input, it synchronizes with the clock from the USB TO HOST jack and MIDI IN connector, respectively.

INT.: Only the internal clock to be used.

- ⚡ When a cable is plugged into the SYNC IN jack, the internal clock is synchronized to the SYNC IN jack clock, regardless of the MIDI clock settings.

USB: Synchronizes with the clock from the USB TO HOST jack.

MIDI: Synchronizes with the clock from the MIDI IN connector.

- ⚡ Please note that when SOURCE is USB or MIDI, the sequencer stops if no external clock input is issued.

HW SETTINGS (Button 14)

BRIGHT (BRIGHTNESS) [1...10]

Adjusts the display brightness.

- ⚡ Continuous use of the drumlogue while the brightness is set to a high value will have an adverse effect on the overall life of the display.

AUTO PWR (AUTO POWER OFF) [OFF, ON]

Sets whether the auto power off feature is enabled.

OFF: The Auto Power Off feature will be disabled.

ON: The Auto Power Off feature is enabled. For details, refer to "Auto Power Off Feature" p.11.

Understanding MIDI and Computers

MIDI stands for Musical Instrument Digital Interface, and is a worldwide standard for exchanging various types of musical data between electronic musical instruments and computers. When MIDI cables are used to connect two or more MIDI devices, performance data can be exchanged between the devices, even if they were made by different manufacturers. MIDI data can also be exchanged between the drumlogue and your personal computer using a single USB cable. The drumlogue lets you assign MIDI control change numbers (CC#) to the major parameters that affect the sound, and control these parameters from an external MIDI sequencer while you play the tone generator. You can also use the front panel knobs or buttons to transmit these control change messages, in order to control an external MIDI device. You can also synchronize the drumlogue's tempo to the MIDI clock of an external MIDI sequencer or other device, so that the drumlogue will play in time with the external device and with any changes you make.

Connecting Devices via MIDI

Controlling an external MIDI device from the drumlogue

If you want to use the drumlogue's keyboard, controllers, and sequencer to play sounds on or to control an external MIDI tone generator, connect the drumlogue's MIDI OUT connector to the external MIDI tone generator's MIDI IN connector using a MIDI cable.

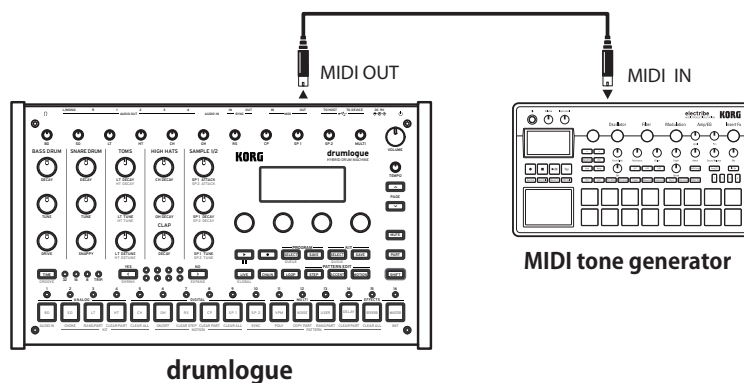

Controlling the drumlogue from an external MIDI device

If you want to play or control the drumlogue from another MIDI keyboard, sequencer, or other device, connect the MIDI OUT connector of the external MIDI device to the drumlogue's MIDI IN connector with a MIDI cable.

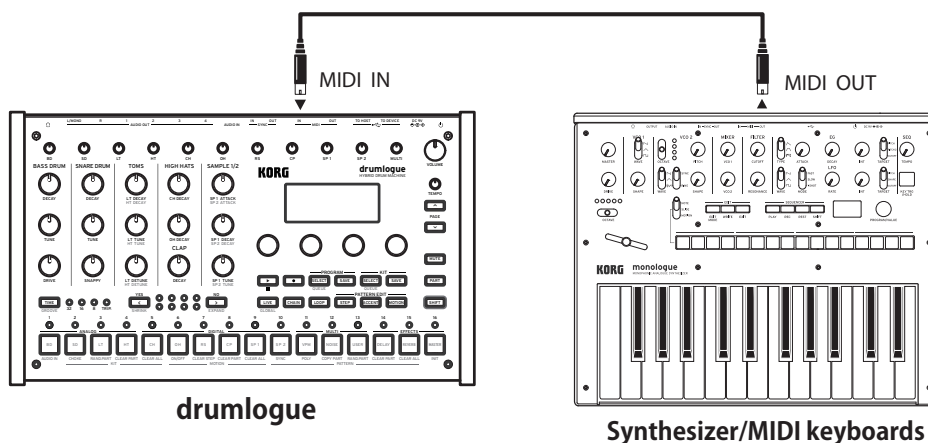

Connecting the drumlogue to a computer via MIDI

You might want to play the drumlogue's keyboard and record your performance on an external MIDI sequencer or computer (connected using the MIDI interface), and then play the drumlogue while monitoring or playing back what you recorded. You also might want to use the drumlogue as both an input device for playing notes and as a MIDI tone generator. In either case, you'll need to connect the MIDI OUT connector to the MIDI IN connector on both the drumlogue and the external MIDI sequencer or computer.

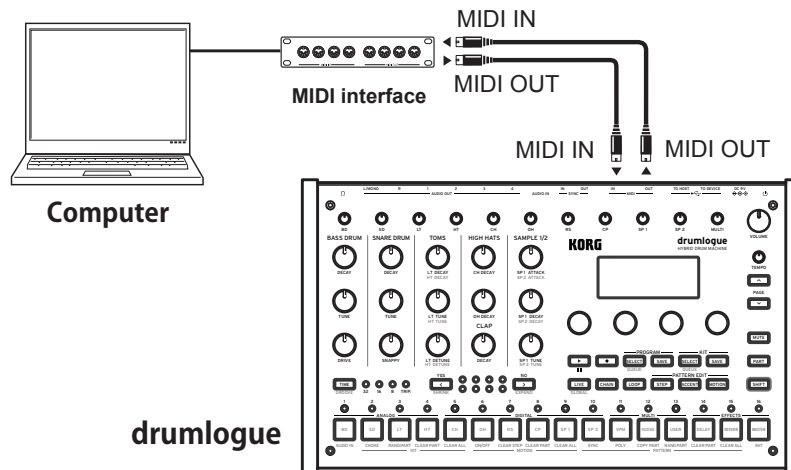

▲ Some MIDI interface devices may be unable to transmit or receive MIDI SysEx messages to or from the drumlogue.

TIP It's convenient to use the USB connector when connecting the drumlogue to a personal computer.

MIDI-Related Settings

Setting the MIDI channel

In order to exchange data with a connected external MIDI device, you must set the drumlogue's MIDI channel to match the MIDI channel of the external MIDI device. Set the MIDI channel of this unit with button 7 "MIDI ROUTING" in Global mode ("MIDI ROUTING (Button 7)" p.46).

TIP When synchronizing to an external MIDI device, refer to that device's Owner's manual.

MIDI filter settings

Use these settings to configure whether program changes and control change messages will be transmitted and received. To send or receive MIDI channel messages, press button 8 "MIDI RX" or button 9 "MIDI TX" in Global mode of this unit ("MIDI RX (Button 8)" p.47), ("MIDI TX (Button 9)" p.47).

Sequencer's Synchronous Performance

To set the sequencer of this unit as the source (control side) or follower (controlled side), press button 12 in Global mode and set "SOURCE" ("CLOCK SOURCE (Button 12)" p.48).

TIP For the settings related to synchronization of external MIDI devices, refer to the instruction manual of the device you are using.

When using this unit as the source and an external MIDI device as the follower

Connect the MIDI OUT connector of this unit to the MIDI IN connector of the external MIDI device.

Set SOURCE in Global mode of this unit to "INT", and set the external MIDI device to receive external MIDI clock. Since this unit is the source, the BPM is set by the TEMPO knob of this unit and MIDI timing clock is sent to the external MIDI device (sequencer, rhythm machine, etc.).

When using an external MIDI device as the source and this unit as a follower

Connect the MIDI IN connector of this unit to the MIDI OUT connector of the external MIDI device.

Set SOURCE in Global mode of this unit to "AUTO", and set the external MIDI device to send the MIDI clock.

When receiving a MIDI timing clock, this unit is automatically set as a follower, and the sequencer operates at the tempo of the external MIDI device (sequencer, rhythm machine, etc.).

- ⚠ Please note that when SOURCE is USB or MIDI, the sequencer stops if no external clock input is issued.

Connecting a computer

Connection to TO HOST (USB B) jack

The drumlogue is a class-compliant USB-MIDI device, and requires no driver for basic MIDI functionality.

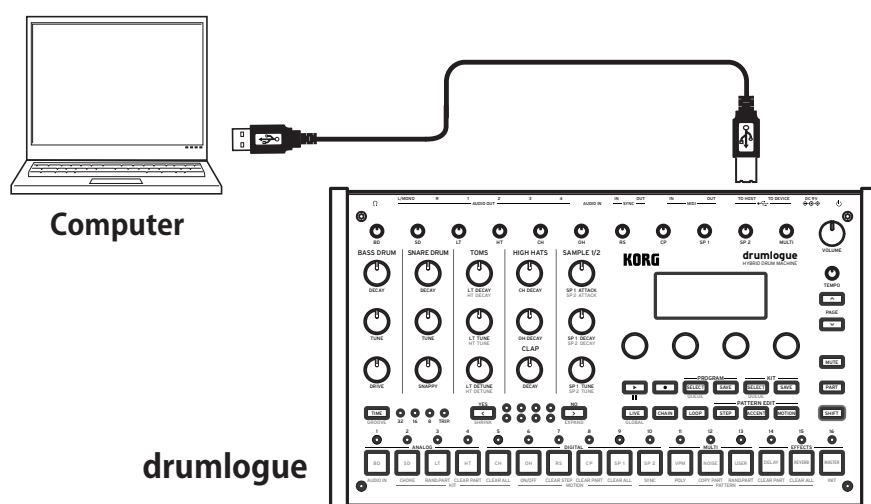

Connection to TO DEVICE (USB A) jack

You can play music by connecting a MIDI controller, etc. to this jack. For example, if you connect KORG nanoPAD 2, you can trigger and play each part with Velocity.

- ⚠ Devices with high current consumption (5V/200mA or more) other than a MIDI controller may not work.

Loading USER SAMPLE

1. Connect the USB (TO HOST) jack of this unit to your computer with a USB cable.
2. Start while holding down the  (REC) button.
3. This unit is recognized as a storage device, and the folder opens.
4. Copy the sample files to the "Samples" folder.
5. When copying is complete, eject the storage device, and then press the (PLAYBACK/STOP) button on this unit.

Loading SAMPLE EXPANSION PACK

1. This procedure is the same as steps 1 to 3 in the above "Loading USER SAMPLE" procedure.
2. Create a folder called "Expansion" in the "Samples/" folder and copy the sample files in the expansion pack.
3. When copying is complete, eject the storage device, and then press the (PLAYBACK)/(STOP) button on this unit.

Loading user synth and effects

1. This procedure is the same as steps 1 to 3 in the above "Loading USER SAMPLE" procedure.
2. Copy each required file.
User synth: Copy the synth's ".drmlgunit" file to the "Units/Synths/" folder.
DELAY effect: Copy the synth's ".drmlgunit" file to the "Units/DelayFXs/" folder.
REVERB effect: Copy the synth's ".drmlgunit" file to the "Units/ReverbFXs/" folder.
MASTER effect: Copy the synth's ".drmlgunit" file to the "Units/MasterFXs/" folder.
3. When copying is complete, eject the storage device, and then press the (PLAYBACK)/(STOP) button on this unit.

<filename rules>

The filename must follow the pattern "XXX_sample_name.wav", where XXX should be three digits (between 001 and 128) indicating the sample index. "sample_name" should only contain alphanumeric characters, and the following special characters: -_!?\$%&'()*+,:;<=>@

Note: Filenames only support single byte ASCII encodings.

⚠ Any files not following the rules above will be deleted from the drumlogue.









<supported format and encodings>

drumlogue natively uses WAV files encoded in 32 bit float with a sampling rate of 48KHz. WAV files encoded in signed 16/24/32 bit PCM and other common sampling rates are supported, but will be automatically converted upon startup.

⚠ If samples must be converted the drumlogue will take more time than usual to startup.

Restoring the Factory settings

You can restore the drumlogue's preset Programs and global settings to their original factory-set state at any time.

- 1. Begin with the drumlogue turned Off.**
- 2. While holding down the SHIFT button and the  (REC) button, turn the drumlogue On.**
"FACTORY RESET" will be indicated in the display.
- 3. Turn Parameter knob 1, and select a target setting (ALL, GLOBALS, PROGRAMS, SAMPLES, UNITS) to return to the factory default.**
ALL: GLOBALS, KITS, PROGRAMS, SAMPLES, and UNITS, all items return to their factory defaults.
 Please note that all data are rewritten to the factory defaults (the saved programs and drum kits are erased).
GLOBALS: The settings of the global parameters return to their factory defaults.
KITS: The preset kits (drum kits A01 to D16) return to their factory defaults.
 This will rewrite the preset kit to factory defaults. If you want to keep the preset kit, use the KIT SAVE button to save it in program banks E01 to H16 in advance.
PROGRAMS: The preset programs (programs A01 to D16) return to their factory defaults.
 This will rewrite the preset program to factory defaults. If you want to keep the preset program, use the PROGRAM SAVE button to save it in program banks E01 to H16 in advance.
SAMPLES: The sample bank of USER and EXP returns to the factory default state.
UNITS: All of the installed logue SDK units (user synth, delay, reverb, master effects) return to their factory defaults.
- 4. Press the  (YES) button.**
The display will indicate the message "Are you sure?".
- 5. Press the  (YES) button again.**
The factory-set default data will be reloaded, and the drumlogue will be restored to its factory default state.
TIP Press the  (NO) button to cancel.
 Never turn off the drumlogue while data is being loaded. Doing so might damage the internal data.

Preset programs/Drum kits

Bank	No.	Program Name	Drum Kit Name	Author	Tempo	Length
A	01	Komputer	Komputer Kit	KORG Inc.	130	32
	02	Electrogram	Electrogram Kit	Hercelot	136	32
	03	Humid Basement	Humid Base Kit	SEKITOVA	124	16
	04	Hard GT	Hard GT Kit	Hercelot	159	16
	05	Digitono	Digitono Kit	KORG Inc.	134	16
	06	Noid	Noid Kit	KORG Inc.	126	64
	07	Rolling	Rolling Kit	KORG Inc.	126	16
	08	Poly Blip	Poly Blip Kit	Hercelot	160	32
	09	Brisk Tambs	Brisk Tambs Kit	KORG Inc.	129	16
	10	Mu Bass	Mu Bass Kit	Hercelot	145	32
	11	Industrial VPM	Industrial Kit	KORG Inc.	130	16
	12	Tape Fiction	Tape Fiction Kit	KORG Inc.	70	16
	13	Bell Swing	Bell Swing Kit	KORG Inc.	124	16
	14	Retro Bossa	Retro Bossa Kit	KORG Inc.	130	16
	15	Slot Machine	Slot Machine Kit	Hercelot	125	32
	16	Double Faced	Double Faced Kit	SEKITOVA	101	16
B	01	Garage Skips	Garage Skips Kit	SEKITOVA	130	32
	02	Half but Fast	Half but Fast Kit	SEKITOVA	138	32
	03	Light Steps	Light Steps Kit	KORG Inc.	132	16
	04	Shuttling	Shuttling Kit	KORG Inc.	150	32
	05	Thrust Forward	Thrust Kit	SEKITOVA	128	16
	06	Compact Set	Compact Set Kit	SEKITOVA	125	16
	07	Time Approaches	Time App Kit	Hercelot	144	16
	08	Rave Cave	Rave Cave Kit	KORG Inc.	134	64
	09	Hard Rubbing	Hard Rubbing Kit	Hercelot	150	32
	10	Prickles	Prickles Kit	KORG Inc.	166	16
	11	Hard Commands	Hard Commands Kit	Hercelot	166	16
	12	Speed Calling	Speed Calling Kit	KORG Inc.	172	32
	13	TV Beats	TV Beats Kit	SEKITOVA	125	16
	14	Planet Elektro	Planet Elektr Kit	KORG Inc.	130	32
	15	Disco Rounds	Disco Rounds Kit	SEKITOVA	118	32
	16	Minimalist System	Minimalist Kit	Hercelot	120	5
C	01	Bear Trap	Bear Trap Kit	KORG Inc.	163	32
	02	Trap Hop	Trap Hop Kit	KORG Inc.	80	32
	03	Disposition	Disposition Kit	KORG Inc.	124	64
	04	Delta Prism	Delta Prism Kit	KORG Inc.	80	12
	05	Funk Boom	Funk Boom Kit	Hercelot	126	32
	06	Get To	Get To Kit	KORG Inc.	164	32
	07	Miryapod	Miryapod Kit	SEKITOVA	143	32
	08	Easy Footwork	Easy Footwork Kit	SEKITOVA	160	16
	09	Dub Hoverer	Dub Hoverer Kit	KORG Inc.	131	16
	10	Back Alley	Back Alley Kit	KORG Inc.	127	16
	11	Modern Minimal	Modern Kit	SEKITOVA	126	16
	12	Land of House	Land of House Kit	SEKITOVA	123	16
	13	Hard Bongos	Hard Bongos Kit	SEKITOVA	135	16
	14	Distorted Air	Distorted Air Kit	KORG Inc.	133	16
	15	Hard Slapper	Hard Slapper Kit	KORG Inc.	132	16
	16	Industbox	Industbox Kit	KORG Inc.	129	16

Bank	No.	Program Name	Drum Kit Name	Author	Tempo	Length
D	01	Jacq Funq	Jacq Funq Kit	KORG Inc.	112	32
	02	Jazzy Breaks	Jazzy Breaks Kit	KORG Inc.	114	32
	03	Downward	Downward Kit	KORG Inc.	91	16
	04	Muffle Funk	Muffle Funk Kit	KORG Inc.	90	16
	05	Heavy Reflection	Heavy Reflec Kit	KORG Inc.	96	16
	06	Mole's Gride	Mole's Gride Kit	KORG Inc.	115	16
	07	Tri Dubwise	Tri Dubwise Kit	Hercelot	118	32
	08	Even Counts	Even Counts Kit	KORG Inc.	120	16
	09	Woodpeck	Woodpeck Kit	Hercelot	124	16
	10	Moving Cows	Moving Cows Kit	Hercelot	120	16
	11	Taiko Loop	Taiko Loop Kit	KORG Inc.	132	16
	12	Blow and Inhale	Blow n Inhale Kit	KORG Inc.	120	16
	13	Electro Receiver	Electro Rcvr Kit	KORG Inc.	128	16
	14	Donca Rock	Donca Rock Kit	KORG Inc.	114	16
	15	Checkout	Checkout Kit	KORG Inc.	122	16
	16	Triplet Pops	Triplet Pops Kit	KORG Inc.	110	16
E	01-16	Init Program	Init Kit	KORG Inc.	120	16
F	01-16	Init Program	Init Kit	KORG Inc.	120	16
G	01-16	Init Program	Init Kit	KORG Inc.	120	16
H	01-16	Init Program	Init Kit	KORG Inc.	120	16

All Programs and Drum Kits were made by SEKITOVA, Hercelot and KORG Inc.

For more information about the authors please visit:

- SEKITOVA

<https://sekitova.net/>

- Hercelot

<https://www.hercelot.com/>

Specifications

Polyphony:	11 voices (User synths may be played polyphonically via MIDI, the actual voice count will depend on the synth's implementation)
Sound source system:	Analog sound source x 4, Digital sound source x 6 (PCM x 4, User sampling sound source x 2), Multi-sound source (VPM, NOISE, User Synth)
Number of Programs (including rhythm patterns):	128 (64 preset programs by factory default)
Number of drum kits:	128 (64 preset kits by factory default)
Effects:	DELAY, REVERB, MASTER
Sequencer:	64 step x 11 parts
Display:	Organic EL (electro-luminescence) display
Control:	Fifteen dedicated panel controls that can instantaneously access parameters
Input/Output terminals:	Headphone jack, OUTPUT (L/MONO, R, AUDIO OUT1 to 4) jacks, SYNC IN/OUT jacks, AUDIO IN jack, MIDI IN/OUT connectors, USB A (TO DEVICE) port, USB B (TO HOST) port
Power supply:	AC adapter (DC9V, )
Power consumption:	9 W
Dimensions (W x D x H):	317 x 189 x 73 mm/12.48" x 7.44" x 2.87"
Weight:	1.4 kg/3.09 lbs.
Included items:	AC adapter, Precautions, Quick Start Guide

* Specifications and appearance are subject to change without notice for improvement.

MIDI Implementation Chart

Function...		Transmitted	Recognized	Remarks
Basic Channel	Default	1–16	1–16	Memorized
	Changed	1–16	1–16	
Mode	Default	X	3	
	Messages	X	X	
	Altered	*****		
Note Number		36–55	36–55	*1
	True voice	*****	36–55	Pitch is unaffected by the note number. *1
Velocity	Note On	X 9n, V=64	O 9n, V=1–127	
	Note Off	X 8n, V=64	X	
After Touch	Key's	X	X	
	Channel	X	X	
Pitch Bend		X	X	
Control Change	7, 39	O	O	MASTER VOLUME MSB, LSB *2
	12, 13, 14	O	O	DELAY PARAM 1, 2, 3 *2
	16, 17, 18, 19	O	O	USER SYNTH PARAM 1, 2, 3, 4 *2
	20, 21, 22, 23, 24	O	O	BD TUNE, DRIVE, ATTACK, DECAY, LEVEL *2
	25, 26, 27, 28, 29	O	O	SD TUNE, SNAP.LV, SNAP.DEC, DECAY, LEVEL *2
	44, 45	O	O	DELAY RETURN, DELAY REVERB SEND *2
	46, 47, 48, 49	O	O	LT TUNE, DETUNE, DECAY, LEVEL *2
	50, 51, 52, 53	O	O	HT TUNE, DETUNE, DECAY, LEVEL *2
	54	O	O	MULTI LEVEL *2
	55, 56, 57	O	O	RS TUNE, DECAY, LEVEL *2
	58, 59, 60	O	O	CP TUNE, DECAY, LEVEL *2
	61, 62, 63	O	O	CH TUNE, DECAY, LEVEL *2
	80, 81, 82	O	O	OH TUNE, DECAY, LEVEL *2
	83	O	O	REVERB RETURN *2
	85, 86, 87, 89	O	O	REVERB PARAM 1, 2, 3, 4 *2
	91	O	O	REVERB LEVEL *2
	92	O	O	DELAY LEVEL *2
	102, 103, 104, 105	O	O	SP1 TUNE, ATTACK, DECAY, LEVEL *2
	106, 107, 108, 109	O	O	SP2 TUNE, ATTACK, DECAY, LEVEL *2
	110, 111, 112, 113, 114, 115	O	O	VPM NOTE, INDEX, RATIO, EG, ATTACK, RELEASE *2
116, 117, 118, 119	O	O	NOISE COLOR, ATTACK, RELEASE, PEAK *2	
120, 121	X	O	ALL SOUND OFF, RESET ALL CONTROLLERS *2	
Program Change		O (0–127)	O (0–127)	*3
	True Number	*****	0–127	
System Exclusive		O	O	*4
System Common	Song Position	X	O	
	Song Select	X	X	
	Tune Request	X	X	
System Real Time	Clock	O	O	*5
	Commands	O	O	*5
Aux Meassages	Local On/Off	X	X	*2
	All Notes Off	X	O (123–127)	
	Active Sensing	O	O	
	System Reset	X	X	
Notes *1 : Note numbers correspond to the following parts, 36: BD, 37: RS, 39: CP, 40: SD, 42: CH, 45: LT, 46: OH, 50: HT, 52: SP1, 53: SP2, 55: MULTI *2 : When the GLOBAL setting MIDI RX CC is ON, the drumlogue will receive signals; and when the GLOBAL setting MIDI TX CC is ON, the drumlogue will transmit signals. *3 : When the GLOBAL setting MIDI RX PRG CHG is ON, the drumlogue will receive signals; and when the GLOBAL setting MIDI TX PRG CHG is ON, the drumlogue will transmit signals. *4 : In addition to Korg exclusive messages, Inquiry is supported. *5 : When the GLOBAL setting CLOCK SOURCE is INT, the drumlogue will not receive signals. The drumlogue will receive signals when set to AUTO. This is the factory default implementation. An alternate multi channel implementation is selectable via the MIDI Global settings, refer to the multi channel implementation chart for details.				

Mode 1: Omni On, Poly
Mode 3: Omni Off, Poly

Mode 2: Omni On, Mono
Mode 4: Omni Off, Mono

O: Yes
X: No

Consult your local Korg distributor for more information on MIDI implementation.

MULTI Ch.

[HYBRID DRUM MACHINE]
Model: DRUMLOGUE

MIDI Implementation Chart

Date: 2022.5.16
Version: 1.01

Function...		Transmitted	Recognized	Remarks	
Basic Channel	Default	1-12	1-12	Memorized. Each part is assigned a separate channel. Any continuous range of channels can be set.	
	Changed	1-16	1-16		
Mode	Default	X	3		
	Messages	X	X		
	Altered	*****			
Note Number		0-127	0-127	Except for the MULTI part, pitch is unaffected by the note number.	
	True voice	*****	0-127		
Velocity	Note On	X 9n, V=64	O 9n, V=1-127		
	Note Off	X 8n, V=64	X		
After Touch	Key's	X	X		
	Channel	X	X		
Pitch Bend		X	X		
Control Change	7, 39	O	O	PART 1-11: LEVEL MSB, LSB. PART 12: MASTER VOLUME MSB, LSB *1	
	10	O	O	PART 1-11: PAN *1	
	91	O	O	PART 1-11: REVERB SEND. PART 12: REVERB LEVEL *1	
	92	O	O	PART 1-11: DELAY SEND. PART 12: DELAY LEVEL *1	
	20, 21, 22, 23, 24, 25, 26	O	O	PART 1: BD TUNE, DRIVE, ATTACK, DECAY, SWEEP, SW.TIME, HOLD *1	
	25, 26, 27, 28, 29	O	O	PART 2: SD TUNE, SNAP.LV, SNAP.DEC, DECAY, TONE *1	
	46, 47, 48, 49, 50, 51	O	O	PART 3: LT TUNE, DETUNE, DECAY, SWEEP, ATTACK, DRIVE *1	
	50, 51, 52, 53, 54, 55	O	O	PART 4: HT TUNE, DETUNE, DECAY, SWEEP, ATTACK, DRIVE *1	
	61, 62, 63, 80, 81	O	O	PART 5: CH TUNE, DECAY, ATTACK, START, END *1	
	80, 81, 82, 83, 85	O	O	PART 6: OH TUNE, DECAY, ATTACK, START, END *1	
	55, 56, 57, 58	O	O	PART 7: RS TUNE, DECAY, START, END *1	
	58, 59, 60, 61, 62	O	O	PART 8: CP TUNE, DECAY, ATTACK, START, END *1	
	102, 103, 104, 105, 106	O	O	PART 9: SP1 TUNE, ATTACK, DECAY, START, END *1	
	106, 107, 108, 109, 110	O	O	PART 10: SP2 TUNE, ATTACK, DECAY, START, END *1	
	108, 109, 110, 111, 112, 113, 114, 115	O	O	PART 11: VPM NOISE, IDX MOD, NOTE, INDEX, RATIO, EG, ATTACK, RELEASE *1	
	116, 117, 118, 119	O	O	PART 11: NOISE COLOR, ATTACK, RELEASE, PEAK *1	
	16, 17, 18, 19, 20, 21, 22, 23	O	O	PART 11: USER SYNTH PARAM 1-8 *1	
	24, 25, 26, 27, 28, 29, 30, 31	O	O	PART 11: USER SYNTH PARAM 9-16 *1	
	12, 13, 14, 15, 16, 17, 18, 19	O	O	PART 12: DELAY PARAM 1-8 *1	
	20, 21, 22, 23, 24, 25, 26, 27	O	O	PART 12: DELAY PARAM 9-16 *1	
	44, 45	O	O	PART 12: DELAY RETURN, DELAY REVERB SEND *1	
	46, 47, 48, 49, 50, 51, 52, 53	O	O	PART 12: MASTER FX PARAM 1-8 *1	
	54, 55, 56, 57, 58, 59, 60, 61	O	O	PART 12: MASTER FX PARAM 9-16 *1	
	83	O	O	PART 12: REVERB RETURN *1	
	85, 86, 87, 89, 90, 102, 103, 104	O	O	PART 12: REVERB PARAM 1-8 *1	
	105, 106, 107, 108, 109, 110, 111, 112	O	O	PART 12: REVERB PARAM 9-16 *1	
	120, 121	X	O	PART 1-12: ALL SOUND OFF, RESET ALL CONTROLLERS *1	
	Program Change		O (0-127)	O (0-127)	*2
		True Number	*****	0-127	
	System Exclusive		O	O	*3
System Common	Song Position	X	O		
	Song Select	X	X		
	Tune Request	X	X		
System Real Time	Clock	O	O	*4	
	Commands	O	O	*4	
Aux Meassages	Local On/Off	X	X	*1	
	All Notes Off	X	O (123-127)		
	Active Sensing	O	O		
	System Reset	X	X		
<p>Notes</p> <p>*1 : When the GLOBAL setting MIDI RX CC is ON, the drumlogue will receive signals; and when the GLOBAL setting MIDI TX CC is ON, the drumlogue will transmit signals. Signals are transmitted on the channel corresponding to the part.</p> <p>*2 : When the GLOBAL setting MIDI RX PRG CHG is ON, the drumlogue will receive signals; and when the GLOBAL setting MIDI TX PRG CHG is ON, the drumlogue will transmit signals.</p> <p>*3 : In addition to Korg exclusive messages, Inquiry is supported.</p> <p>*4 : When the GLOBAL setting CLOCK SOURCE is INT, the drumlogue will not receive signals. The drumlogue will receive signals when set to AUTO.</p> <p>This is an alternate implementation selectable via MIDI Global settings. For the default single channel implementation refer to the single channel implementation chart.</p>					

Mode 1: Omni On, Poly
Mode 3: Omni Off, Poly

Mode 2: Omni On, Mono
Mode 4: Omni Off, Mono

O: Yes
X: No

Consult your local Korg distributor for more information on MIDI implementation.

KORG INC.

4015-2 Yanokuchi, Inagi-City, Tokyo 206-0812 JAPAN

© 2022 KORG INC. www.korg.com

Published 11/2022